



July
25 Cent

Radio-Craft

for the
Professional-Serviceman-Radiotrician

HUGO GERNSBACK Editor

Prot



IN THIS ISSUE

Articles by
L. M. COCKADAY
SYLVAN HARRIS
DAVID GRIMES
And Many Others

Men who have made Radio: Gen. G. Ferrie



BIG MONEY NOW!

More to Come

Radio now offers ambitious men the greatest Money-Making Opportunity the world has ever seen! Hundreds of trained service men are needed by radio dealers, jobbers, and manufacturers!

A "trained" Radio "Service and Repair" man can easily make \$40 to \$50 a week, and it's very common for a trained man with experience to make \$75 a week and up.

BIG MONEY for Spare-Time Radio Work is easily made in every city and village. You can now qualify for this Big-Money work quickly through R. T. I. Get the Big Money Now and go up and up in this Big Pay field. The Radio industry calls for More Men, and R. T. I. supplies what the industry wants you to know.

No Experience Needed

ALL YOU NEED is ambition and the ability to read and write. The Radio industry needs practical trained men. Remember, R. T. I. makes it easy to earn spare time money while you learn at home.

More to come

THE MEN who get into this Big-Money field now will have an unlimited future. Why? Because this billion dollar Radio industry is only a few years old and is growing by leaps and bounds. Get in and grow with it. \$10 to \$25 per week and more is easily made in spare hours while you are preparing for Big Money. TELEVISION, too, will soon be on the market, so the leaders say. Be ready for this amazing new money-making field. Remember, R. T. I. "3 in 1" home-training gives you all the developments in Television and Talking Picture Equipment, together with the complete Radio Training.

Supervised by Radio Leaders

R. T. I. training is prepared and supervised by prominent men in radio, television and talking picture engineering; distributing; sales; manufacturing; broadcasting, etc. These men know what you must know to make money in Radio. You learn easily in spare time at home with the R. T. I. wonderful combination of Testing Outfits, Parts, Work Sheets, Job Tickets.

It is easy, quick and practical, covers everything in Radio — includes Talking Pictures and the latest in Television. Get started in Big Money Radio work now.

Warning

Do not start R. T. I. training if you are going to be satisfied to make \$15 or \$20 per week more than you are now. Most R. T. I. men will make that much increase after a few weeks. There is no reason to stop short of the Big Money Jobs or the Big Profits in a spare time or full time business of your own. No capital needed. Get started with R. T. I. now. Make money while you learn at home.

R. T. I. Book Now

FREE

The thrilling story of Radio, Television and Talking Pictures is told with hundreds of pictures and facts — its hundreds of big money jobs and spare time money-making opportunities everywhere.

Send for your copy now. USE THE COUPON.



LET F. H. SCHNELL AND R. T. I. ADVISORY BOARD HELP YOU!

Mr. Schnell, Chief of the R. T. I. Staff, is one of the ablest and best known radio men in America. He has twenty years of Radio experience. First to establish two-way amateur communication with Europe. Former traffic manager of American Radio Relay League, Lieutenant Commander of the U. S. N. R. Inventor and designer of Radio apparatus. Consultant Engineer to large Radio manufacturers. Assisting him is the R. T. I. Advisory Board composed of men prominent in the Radio industry.



\$60-\$70-\$80-PER WEEK AND UP. That's what R. T. I. training leads to. Send for the R. T. I. Book and see for yourself.

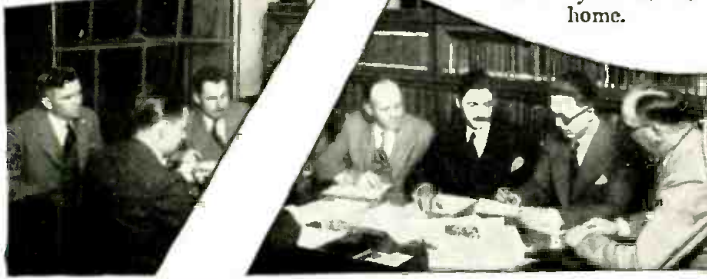

THE R. T. I. ADVISORY BOARD. These men are executives with important concerns in the radio industry — manufacturing, sales, service, broadcasting, engineering, etc., etc. They supervise R. T. I. Work Sheets, Job Tickets, and other training methods.

RADIO & TELEVISION INSTITUTE
Dept. 76-B 4806 St. Anthony Ct., Chicago

RADIO & TELEVISION INSTITUTE
Dept. 76-B 4806 St. Anthony Court, Chicago

Send me Free and prepaid your BIG BOOK "Tune In On Big Pay" and full details of your three-in-one Home Training (without obligating me in any way).

Name.....
Address.....
City..... State.....

R. T. I. R. T. I. TRAINS YOU AT HOME FOR A GOOD JOB OR A PROFITABLE PART TIME OR FULL TIME BUSINESS OF YOUR OWN

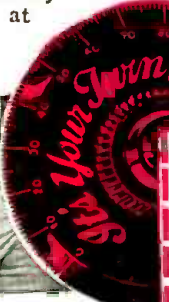

5,000

Radio Service Men Needed Now!



The replacing of the old battery operated receivers with all-electric Radios has created a tremendous country-wide demand for expert Radio Service Men. Thousands of trained men are needed quick!

30 Days of R.T.A. Home Training

... enables you to cash in on this latest opportunity in Radio

\$40 to \$100
a week
Full Time
\$3.00 *an hour*
Spare Time

Ever on the alert for new ways of helping our members make more money out of Radio, the Radio Training Association of America now offers ambitious men an intensified training course in Radio Service Work. By taking this training you can qualify for Radio Service Work in 30 days, earn \$3.00 an hour and up, spare time; prepare yourself for full-time work paying \$40 to \$100 a week.

hour spare time or \$40 to \$100 a week full time, this R. T. A. training offers you the opportunity of a lifetime.

More Positions Open Than There Are Trained Men to Fill Them

If you were qualified for Radio Service Work today, we could place you. We can't begin to fill the requests that pour in from great Radio organizations and dealers. Members wanting full-time positions are being placed as soon as they qualify. 5,000 more men are needed *quick!* If you want to get into Radio, earn \$3.00 an

We furnish you with all the equipment you need to become a Radio Service Man!

Radio Service Work a Quick Route to the Big-Pay Radio Positions

Radio Service Work gives you the basic experience you need to qualify for the big \$8,000, \$10,000 to \$25,000 a year Radio positions. Once you get this experience, the whole range of rich opportunities in Radio lies open before you. Training in the Association, starting as a Radio Service Man, is one of the quickest, most profitable ways of qualifying for rapid advancement.

If you want to get out of small-pay, monotonous work and cash in on Radio quick, investigate this R. T. A. training and the rich money-making opportunities it opens up. No special education or electrical experience necessary. The will to succeed is all you need.

Mail Coupon for No-Cost Training Offer

Cash in on Radio's latest opportunity! Enroll in the Association. For a limited time we will give to the ambitious man a No-Cost Membership which need not . . . should not . . . cost you a cent. But you must act quickly. Filling out coupon can enable you to cash in on Radio within 30 days, lift you out of the small-pay, no-opportunity rut, into a field where phenomenal earnings await the ambitious. You owe it to yourself to investigate. Fill out coupon NOW for details of No-Cost Membership.

The Radio Training Association of America
4513 Ravenswood Ave. Dept. RCA-7, Chicago, Ill.

THE RADIO TRAINING ASSOCIATION OF AMERICA
4513 Ravenswood Ave., Dept. RCA-7 Chicago, Ill.
Gentlemen: Please send me details of your No-Cost training offer by which I can qualify for Radio Service Work within 30 days. This does not obligate me in any way.

Name.....
Address.....
City..... State.....

H. GERNSBACK, President
 S. GERNSBACK, Treasurer
 J. M. HERZBERG, Vice-President
 I. S. MANHEIMER, Secretary



JOHN F. RIDER,
 Editor Service Dept.

R. D. WASHBURNE,
 Technical Editor

C. P. MASON,
 Associate Editor

HUGO GERNSBACK, Editor-in-Chief

VOLUME II
 NUMBER 1

Contents of This Issue

JULY
 1930

	PAGE		PAGE
EDITORIAL:		SHORT-WAVE CRAFT	
Men Who Believe in Radio.....By Hugo Gernsback	9	A Portable Short-Wave Set of New Design By Clifford B. Himoe	28
SERVICE MEN'S DEPARTMENT:		Spreading Short-Wave Stations on the Dial.....	29
Modernizing the Old Receivers.....By R. R. Mayo	10	List of Short-Wave Stations of the World.....	30
Leaves from Service Men's Notebooks By RADIO-CRAFT Readers	11	MODERN SOUND PROJECTION	
Service Hints on Some Popular Receivers By Harold Weiler	12	(VI) Keeping Extraneous Noises out of Sound-on-Film By E. C. Brinkmeyer	31
A Vacuum-Tube Multi-Meter.....By Beryl B. Bryant	13	AUTOMOTIVE RADIO:	
Who Has the Right to the Patent?....By J. Harold Byers	15	A Screen-Grid Superheterodyne for Motor-Car Use By H. G. Cisin	32
Operating Notes for Service Men—By Bertram M. Freed	16	Solving Automotive Antenna Problems.....	33
The Service Man's Open Forum.....	17	EXPERIMENTAL AND CONSTRUCTIONAL	
RADIO SERVICE DATA SHEETS:		Obtaining "B" Power from a Storage Battery By L. B. Robbins	34
(21) Silver Models 30, 60, 95 and 75.....	18	The Broad Frequency-Acceptor By Henri Francois Dalpayrat	36
(22) Eveready Series 30, 30-C and 40.....	19	The Radio Craftsman's Own Page.....By Himself	38
Fidelity or Volume in Reproduction?....By Sylvan Harris	20	THE COOPERATIVE RADIO LABORATORY	
NEW DEVELOPMENTS IN RADIO:		A Direct-Coupled Push-Pull Amplifier..By David Grimes	39
The Latest Developments in Television Methods By Laurence M. Cockaday	22	Review of Recent Radio Literature.....	41
Men Who Have Made Radio (No. X) Gen. G. A. Ferrié	24	RADIO-CRAFT'S Information Bureau	
The Amateur's Television Projector By Alexander Gordon Heller	25	RADIO-CRAFT'S Opportunity Column	
Why is Code Used?.....By J. E. Smith	26	Letters from Short-Wave Fans.....	
New Radio Devices for Shop and Home.....	27	58	

In Forthcoming Issues

A COMBINATION SHORT-WAVE AND BROADCAST RECEIVER, by Samuel Whisk. This is a set of unusually high quality, with a range from 15 to 600 meters; the shift on the wavebands is obtained instantly, not by plugging in coils, but by switching. With the full data given, this article will appeal to all constructors.

A PUBLIC-ADDRESS ADAPTER, by Howard Smith. This device has been adopted by many metropolitan radio dealers, as an addition to their display. It plugs into the detector

socket of any set and converts its regular audio channel into a speech amplifier operating from a hand or studio microphone.

INTERNAL TROUBLES OF LATE TUBE MODELS, by Sylvan Harris. Mr. Harris analyzes for us a few difficulties which have accompanied the production of recent improved tubes. The discussion will be found educational and profitable.

And Many Other Practical Articles.

RADIO-CRAFT is published monthly, on the fifth of the month preceding that of date; its subscription price is \$2.50 per year. (In Canada and foreign countries, \$3.00 a year to cover additional postage.) Entered at the postoffice at Mt. Morris, Ill., as second-class matter under the act of March 3, 1879. Title registered U. S. Patent Office. Trademarks and copyrights by permission of Gernsback Publications, Inc., 95 Park Place, New York City.

Text and illustrations of this magazine are copyright and must not be reproduced without permission of the copyright owners. We are also agents for WONDER STORIES, AMAZING DETECTIVE TALES and WONDER STORIES QUARTERLY. Subscriptions to these magazines may be taken in combination with RADIO-CRAFT at reduced Club rates. Write for information.

Copyright 1930, GERNSBACK PUBLICATIONS, INC.

Published by
TECHNI-CRAFT PUBLISHING CORPORATION

Publication Office: 404 No. Wesley Ave., Mount Morris, Illinois

Editorial and Advertising Offices
 96-98 Park Place, New York City

Western Advertising Office
 737 North Michigan Avenue, Chicago, Ill.

L. F. McCLURE, Western Advertising Representative

London Agent: Hachette & Co.,
 16-17 King William St., Charing Cross, W.C. 2

Paris Agent: Hachette & Co.,
 111 Rue Reaumur

Australian Agent: McGill's Agency,
 179 Elizabeth St., Melbourne

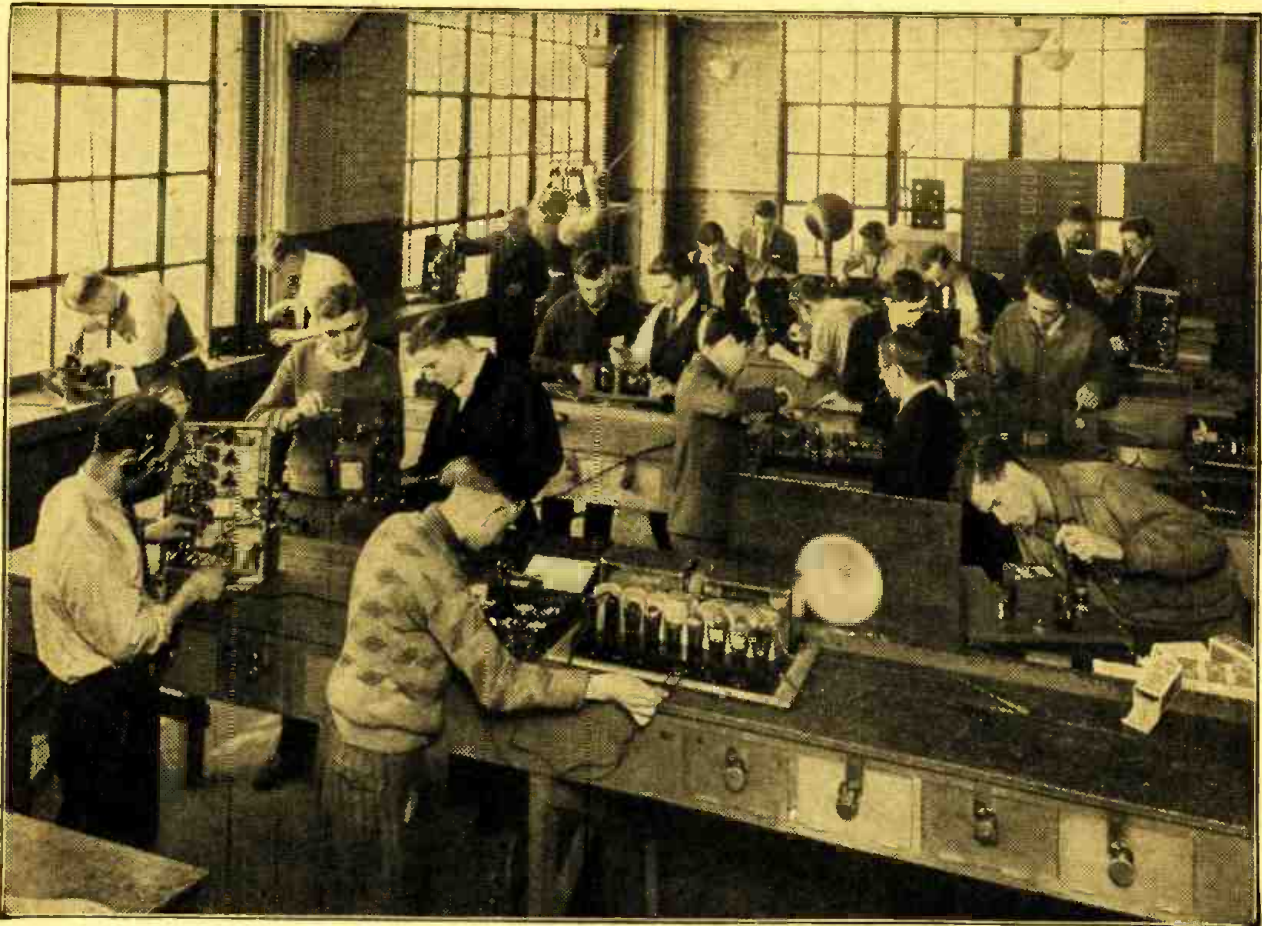

YOU Radio Men!

STATISTICS in the radio industry show that at the present time the ordinary radio man, either as a repair man or Service Man, makes an average of \$35.00 a week. Let us show you how you can quickly qualify for jobs leading to salaries of \$60.00, \$70.00, or \$100.00 a week and up—NOT by books or correspondence, but by an entirely new way.

We Teach You How—No Books—No Lessons—No Classes!

Coyne is not a correspondence school. We actually show you, by expert instructors, every phase of radio; which it is impossible to learn from books or from correspondence courses.

The majority of Radio Service Men and radiotricians today do not earn what they should, because they have never been properly grounded in the fundamentals of radio—that is to say, in electricity.

Remember, you will never qualify as an expert radio man unless you know the fundamentals of electricity. All of this is taught by ACTUAL WORK on real equipment in our school.

From \$20.00 a Week to \$100.00 a Week

"Before going to Coyne, I had worked in a garage for five years at \$20.00 a week. I had no advanced education and didn't know a volt from an ampere. Yet I graduated in three months with a grade of 98%. Since I left Coyne, I have jumped from \$20.00 to \$100.00 a week, and am still going strong. I owe all my success to the practical training I got in the Coyne Shops."—Harry A. Ward, Iowa.

COYNE ELECTRICAL SCHOOL, H. C. Lewis, Pres. 500 S. Paulina St. Founded 1899 Dept. BO-85, Chicago, Ill.

Most self-taught radio Service Men fail utterly because their electrical-education has been neglected; and, incidentally, they lose a good income because statistics show that radio alone cannot support the independent radio man all year around.

In the Spring and Summer time, particularly, radio is notoriously dull; and the radio man who is an electrical expert will make more money in the end.

Radio Training

The photograph above shows how men are actually trained in our big radio shop, where students are shown by experts how to take apart and put together the various modern radio sets. We will show you how to get at the root of servicing troubles; and within 90 days you can be a radio expert.

Most radio men today flounder around because they do not know the peculiarities of many sets, and have to puzzle these out, tediously, for themselves; whereas our instructors, with years of experience behind them, can show you how to locate any set troubles.

No Previous Training Necessary!

Remember, I do not teach you out of books. You are actually doing the work yourself, and get all the experience you need right here at Coyne.

I do not care whether you cannot tell a vacuum tube from a C-battery; whether you are sixteen years old or forty-five. It is my job to prepare YOU for a big-pay radio and electrical job in 90 days' time.

The Future of Radio

At the present time, there is a dire need for REAL and experienced Service Men, who

also know the ins-and-outs of electricity. Even though you may work on a good salary job for an employer at first, sooner or later you will wish to establish yourself in your community and start in business for yourself. The combination of radio and electricity cannot be beat; it is an all-year-round business.

Even if you do not want to go in business, there are more jobs today than good men to fill them. Coyne training settles the job question for life. Only recently one concern called on me for 150 graduates, and calls for more men are coming in daily. Coyne maintains an expert Employment Department, which will help you and back you as long as you live, WITHOUT ONE CENT OF COST TO YOU.

Special Offer!

In connection with the radio training, you are also given electrical training in all its branches—auto ignition and aviation electricity—WITHOUT ONE CENT EXTRA COST!

Get My Free Book

Mail the coupon today, and let me send you the big Coyne book of 150 photographs—facts—jobs—salaries. It costs nothing, and does not obligate you in any way. Just mail the coupon.

MAIL THIS COUPON—NOW!

Mr. H. C. LEWIS, President
COYNE ELECTRICAL SCHOOL, Dept. BO-85
500 S. Paulina St., Chicago, Ill.

Dear Mr. Lewis:

Without obligation send me your big free catalog and all details of Railroad Fare to Chicago, Free Employment Service, Radio, Aviation Electricity, and -Automotive Courses, and how I can "earn while learning."

Name
Address
City..... State.....

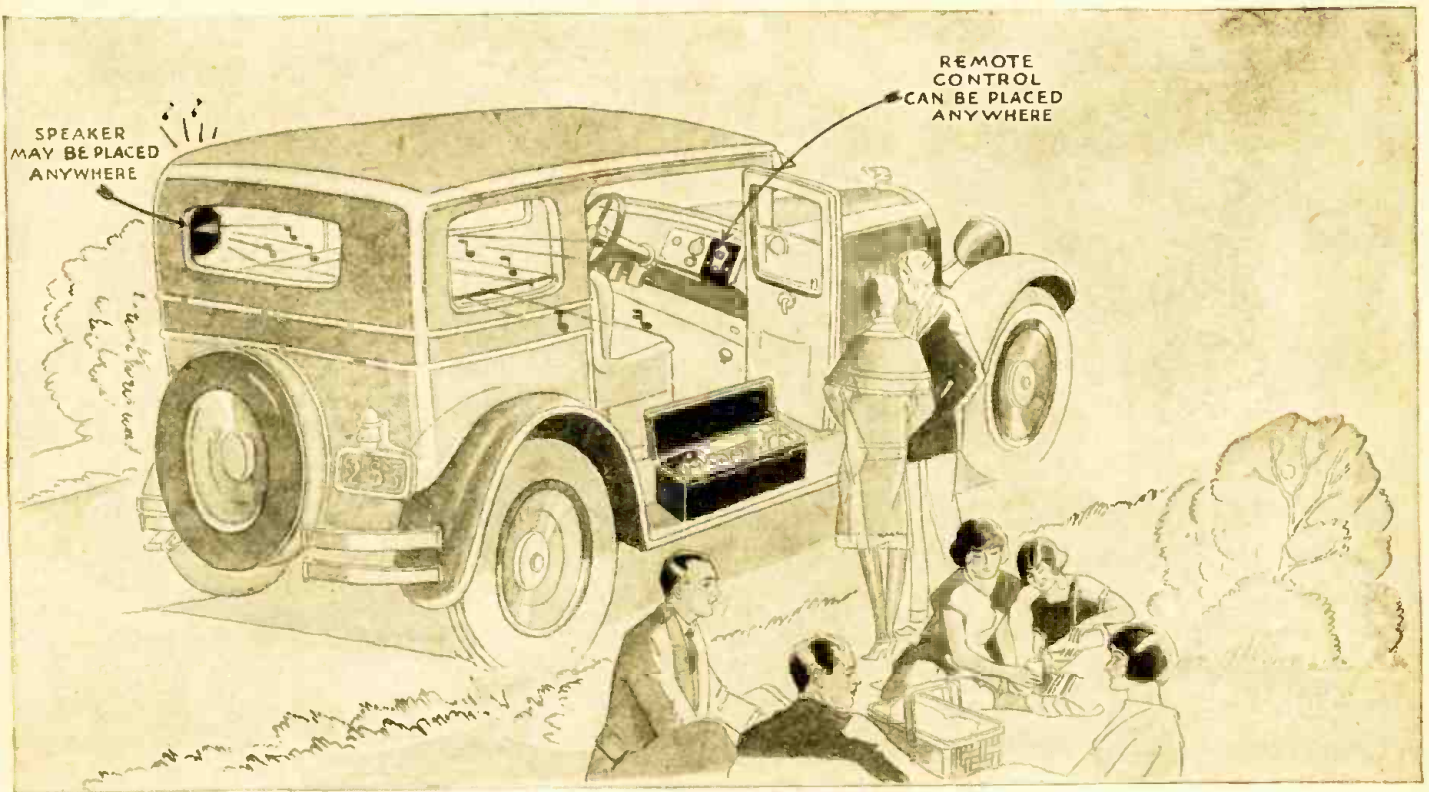

The "AUTO PILOT" goes on your running board and does not lessen the car's trade-in value when taken off to go on your next car

"Auto Pilot" Full Screen Grid Radio

LICENSED UNDER R.C.A. PATENTS

Increases Your Automobile Pleasure

Nobody will have a more up-to-date automobile than yours when you have assembled this powerful "AUTO PILOT" Screen Grid broadcast receiver kit, placed it on your running board in its attractive black japanned case and connected its remote control dial and speaker. Even the specially designed PILOT "undercar" aerial attaches between the axles without necessity for harming your car's exterior or interior.

This new and advanced "AUTO PILOT" not only has every up-to-date feature of radio to assure you distance, selectivity, tone quality and volume—but the welfare and future trade-in value of your car has also been a chief consideration of design. The New "AUTO PILOT" requires no mutilation of floor, instrument board or upholstery to make a solid installation—convenient to operate, taking up no foot or seat room.

You Can Install the "Auto Pilot" in Your Car in An Evening.

Four-224 A.C. Screen Grid Pilotrons comprising three stages of radio frequency and detector give the "Auto Pilot" tremendous pick-up and distance range. A. C. Pilotrons are operated from the car's battery instead of battery type tubes because they are rugged and non-microphonic.



Auto Pilot Kit 4750
Complete with aerial less
Pilotrons and Speaker

Thick sponge rubber mountings take up road shocks. The audio amplifier system gives enough volume for outdoor dancing, with tone quality of the highest order. Filament current drain from car's storage battery is only 4 amperes. Plate current is 20 milliamperes from three 45-volt "B" batteries.

Inquire of your local Pilot Radio Dealer or write direct to

PILOT RADIO & TUBE CORP.

323 BERRY ST., BROOKLYN, NEW YORK

Chicago Office: 231 South Wells St.

San Francisco Office: 1278 Mission St.

FACTORIES AT LAWRENCE, MASS.



PILOTRON RADIO TUBES

Endorsed by Professionals

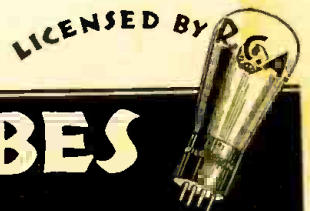

Laugh at me if you want to



I used to think
the same as you do

that I knew all there was
to know about Radio ---

*But this training
showed me I was
kidding myself*

FOUR months ago I belonged to that large number of men and young men who have at one time or another been fans, amateurs, set builders, and service men. Since I learned everything I knew about Radio by working with different sets and circuits, doing a lot of experimenting at nights, I began to believe there was no other way to learn Radio and learn it right.

Something Happened

Two fellows I had been working with were promoted ahead of me. Johnson was made buyer at the store with a nice raise in salary, and Williams hooked up with a manufacturer in a State Service Manager's job—also getting a nice raise. When I told my friends about it and told them that Johnson and Williams had taken a certain correspondence course and that I was thinking of doing the same thing, all I got was the ha! ha! I must admit I was very skeptical myself. I wasn't at all convinced that a person could learn very much by mail, especially about Radio. But I decided to find out. I knew it would only cost a two-cent stamp, so largely out of curiosity I sent in a coupon.

I Got a Surprise

I found out that others, judging from the jobs they held and the money they were making, had apparently learned more about Radio in six months to one year under a systematic plan of training than I had learned in 10 years trying to dig it out for myself. I used to think that the only fellows who took a correspondence course were young fellows out in the sticks who really didn't have a chance to learn Radio any other way. When I read letters from amateurs, service men, fans and beginners, telling of the profits they made—salaries larger than I was making—I decided to take a chance on the course myself.

I Got a \$40 a Month Raise

Of course you want to know how I made out. My boss has already taken a new notice of my work. He no longer thinks of my salary as overhead—a necessary evil. He says I am a good man. A real asset and value to his company. In fact he has given me a \$40 a month raise. That raise in one year will pay for my training about five times. So if I never earn another cent my investment is already a profitable one.

The fine outlay of Lesson Texts, Service Sheets, Job Sheets and Work Sheets that I received have placed right at my fingers' tips priceless knowledge about Radio Sets, Television, Talking Movies, Broadcasting Stations, Ship Apparatus, Commercial Land Stations, and Aviation Radio which I had been trying to dig out and piece together for the past ten years.

I Found a New Use Being Made of Radio Parts

They also sent me some Radio parts. Well, I wasn't very enthused about those parts because I had fooled with so many different pieces of Radio apparatus, they weren't new to me at all. But boys, when I got busy doing the experiments and the laboratory work they laid out for me, they certainly gave me an eye opener. I had no idea that so much could be taught about Radio with parts. But it's the method that does the trick. It may have taken me ten years more to pick up from my own experience everything they taught me with these outfits in a few months.

I am not through with the course yet—only a little over half way but I am not afraid to tackle most any kind of a job. Where I used to be limited to set servicing, and I wasn't any too good at it, now I wouldn't be afraid to design a good broadcasting station and put it on the air without outside help. For that matter I can tackle most any

kind of job feeling confident that I could hold it.

I Made a Big Mistake

That mistake has cost me a lot of money—money which I should have in the bank now. What I really should have done was to have taken this course five years sooner. My boss told me just the other day that when I finish he is going to take me into partnership and then I will make some real money.

Take My Tip

Write to Mr. Smith, President of the outfit that gave me my training and put it up to him to show you what he can do for you. It will only cost you a two-cent stamp. It may save many years of wasted time and heart-breaking struggle trying to dig out for yourself what you really need to know if you expect to get ahead in Radio. I used to be one of the wise guys who laughed at the idea. But I admit frankly I was wrong. When I sent in that coupon it was the best step I ever made in my life. I think you will find it the same way, but you can decide that for yourself as Mr. Smith will be glad to send you full information without any obligation to you. Simply mail the coupon.

J. E. SMITH, President,
National Radio Institute, Dept. OGY,
Washington, D. C.

Dear Mr. Smith: Without obligating me and without sending an agent, prove to me that your training is not only of value to beginners, but also to service men, fans, amateurs and others who already know something about Radio.

Name

Address

City..... State.....

◆ ◆ *Official*
RADIO SERVICE MANUAL

*and Complete Directory of
 all Commercial Wiring
 Diagrams of Receivers*

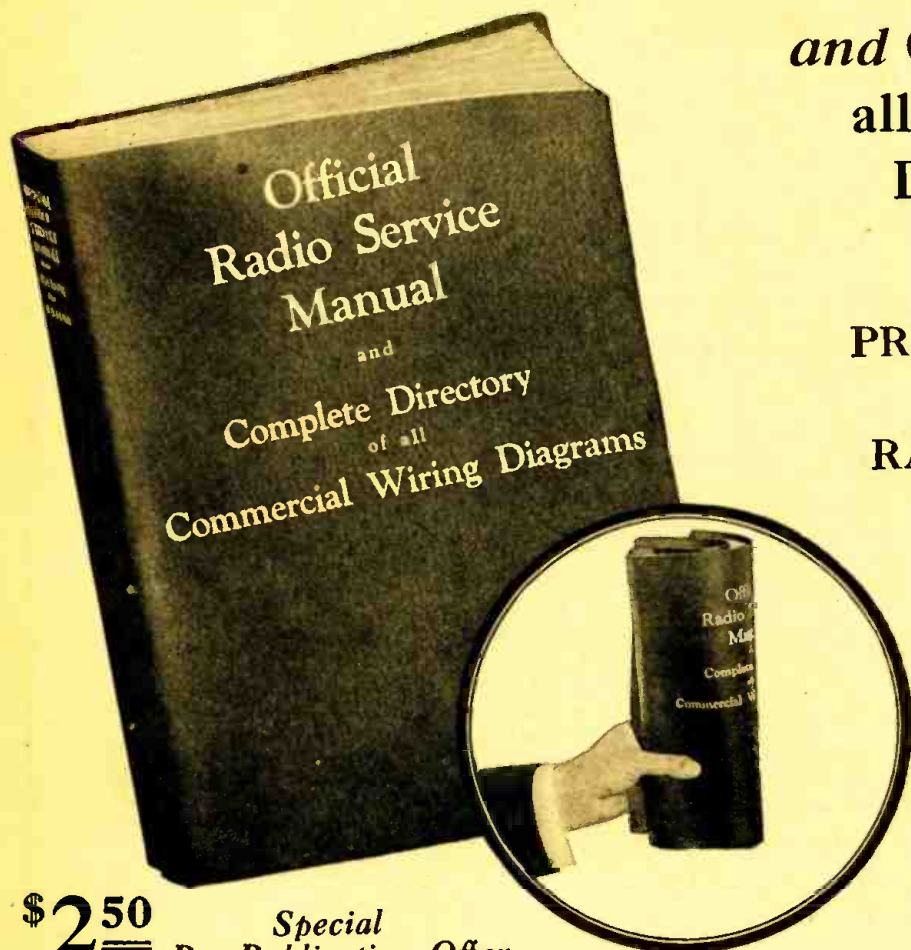

PREPARED ESPECIALLY
 FOR THE
 RADIO SERVICE MAN !

HUGO GERNSBACK
Editor

CLYDE FITCH
Managing Editor

\$2.50 *Special
 Pre-Publication Offer*

WE ANNOUNCE the early publication of the long-awaited OFFICIAL RADIO SERVICE MANUAL. This manual is the first complete and most up-to-date book of this kind. Nothing else like it has ever appeared in print.

A tremendous amount of material has been collected, not only for the Service Man, but for everyone interested in radio. A complete directory of every radio circuit of commercial receivers is now possible, and not only to get every circuit of every set ever manufactured, of which there is any record, but in addition, an entirely new idea makes it possible to keep the manual up-to-date.

The OFFICIAL RADIO SERVICE MANUAL is made in loose-leaf form—handsomely made of flexible leatherette—the entire book can be folded and slipped easily into your pocket or put in your bag.

Rarely do manufacturers supply information about receivers made before 1927—even 1930 service data are not always available because many manufacturers do not supply independent Service Men with such data. And, when you can get the material from some of the manufacturers, it is of little use to you because it is not uniform, and it is scattered in different places; difficult to get at.

Additional service data, for new receivers as they appear on the market will be published and supplied at trifling cost so that the MANUAL may be kept up-to-date at all times.

SERVICE INFORMATION

But that is not all. The OFFICIAL RADIO SERVICE MANUAL contains also a most comprehensive instruction

course for radio Service Men, giving practical information from every angle on how to service sets.

In short, the OFFICIAL RADIO SERVICE MANUAL is the biggest thing of its kind that ever came along in radio. It will be hailed by every wide-awake radio man throughout the entire industry.

The size of the OFFICIAL RADIO SERVICE MANUAL is 9 in. by 12 in. There are several hundred pages, printed on good paper, and the book contains hundreds of illustrations and diagrams.

SPECIAL OFFER

The price will be \$3.50 upon publication of the book; but to our own subscribers and readers, we have a special pre-publication price of \$2.50, prepaid. This price will be withdrawn the minute the book is published, which will be during the next six weeks or sooner.

GERNSBACK PUBLICATIONS, INC., 96-98 Park Place, New York, N. Y.		RC-7
As per your special offer, I enclose herewith \$2.50 for which you are to send me postpaid, one copy of the OFFICIAL RADIO SERVICE MANUAL as soon as it is published, at the pre-publication price of \$2.50. I understand that the price will be \$3.50 as soon as the MANUAL is published.		
Name		
Address		
City.....	State.....	

SERVICE THE BETTER WAY

THE 3-METER
MODEL 245

SET and TUBE TESTER

TESTS SCREEN-GRID

This reliable instrument is now used by thousands of successful service men. Plugs into set socket. Tests made with speed of tubes and circuits. Checks line voltage. Meters can be used individually. Illustrated instructions. Seamless steel case. Beautiful baked enamel finish. Built to stand hard service in the field. Simple. Compact. Accurate. Supremely practical.



Your jobber can supply you. If ordered direct remittance must accompany order.



Readrite

\$12 NET
\$20 List

SPACE D-47 RMA SHOW, ATLANTIC CITY, JUNE 2-6

READRITE METER WORKS
17 College Ave., BLUFFTON, OHIO

Manufacturers of

PRACTICAL SERVICING INSTRUMENTS FOR A.C. & D.C.

ESTABLISHED 1904

Announcement!



NATIONAL RADIO SERVICE MEN'S ASSOCIATION

BOARD OF DIRECTORS

L. M. Cockaday

David Grimes

John F. Rider

Hugo Gernsback

Sidney Gernsback

I. S. Manheimer



EVER since the appearance of the commercial radio broadcast receiver as a household necessity, the Radio Service Man has been an essential factor in the radio trade; and, as the complexity of electrical and mechanical design in receivers increases, an ever-higher standard of qualifications in the Service Man becomes necessary.

The necessity, also, of a strong association of the technically-qualified radio Service Men of the country is forcing itself upon all who are familiar with radio trade problems; and their repeated urgings that such an association must be formed has led us to undertake the work of its organization.

This is the fundamental purpose of the NATIONAL RADIO SERVICE MEN'S ASSOCIATION, which is not a money-making institution, or organized for private profit; to unite, as a group with strong common interests, all well-qualified Radio Service Men; to make it readily possible for them to obtain the technical information required by them in keeping up with the demands of their profession; and, above all, to give them a recognized standing in that profession, and acknowledged as such by radio manufacturers, distributors and dealers.

To give Service Men such a standing, it is obviously necessary that they must prove themselves entitled to it; any Service Man who can pass the examination necessary to demonstrate his qualifications will be elected as a member and a card will be issued to him under the seal of this Association, which will attest his ability and prove his identity.

The terms of the examination are being drawn up in co-operation with a group of the best-known

radio manufacturers, as well as the foremost radio educational institutions.

The following firms are co-operating with us:

- GRIGSBY-GRUNOW CO (Majestic), CHICAGO
- STROMBERG-CARLSON TELEPHONE MFG. CO., ROCHESTER, N. Y.
- CROSLEY RADIO CORP., CINCINNATI, OHIO
- COLIN B. KENNEDY CORP., SOUTH BEND, IND.

The schools who have consented to act as an examination board are:

- International Correspondence Schools, Scranton, Penna.; Mr. D. E. Carpenter, Dean.
- RCA Institutes, Inc., New York, N. Y.; Mr. R. L. Duncan, President.
- Radio & Television Institute, Inc., Chicago, Ill.; Mr. F. G. Wellman, Managing Director.
- Radio Training Association of America, Chicago, Ill.; Mr. A. G. Mohaupt, President.
- School of Engineering of Milwaukee, Milwaukee, Wisc.; Mr. W. Werwath, President.
- Rider-Goll Radio School, New York, N. Y.; Mr. John F. Rider, Director.

We shall not attempt to grade the members into different classes. A candidate will be adjudged as either passing or not passing. If the school examining the papers passes the prospective member as satisfactory, we shall issue to him an identification card with his photograph.

If the candidate does not pass this examination the first time, he may apply for another examination three or six months later.

There is absolutely no cost attached to any service rendered by the Association to its members, no dues, no contributions.

If you wish to become a member, just fill out the coupon below and mail it to us. We will send you all the papers necessary to become a member.

N. R. S. M. A.,
c/o RADIO CRAFT,
98 Park Place,
New York, N. Y.

I wish to become a member of your Association. Please mail me the examination papers and application blanks.

Name

Address

Town..... State.....



Men Who Believe in Radio

By Hugo Gernsback

EVERY once in a while, the cry goes up from certain members of the radio trade, that radio has been played out, that there is no more money in it, and that there is little future ahead for radio as a whole.

On the face of the situation, such statements might be unthinkingly accepted; because it is a fact that there are now fewer radio parts manufacturers, by far, than there were in 1924. This is true also of the set manufacturers; the shrinkage here has been very considerable and it is true that there are left only a fraction of the numbers of several years ago.

This, however, does not mean that radio on the whole is on a decline. Quite the contrary is true. When a census is taken, and the outputs of all manufacturers in the entire radio industry are added together, it will be found that there has been a steady increase in the total, year by year, since 1920. And, while today there are fewer radio set manufacturers and fewer radio parts manufacturers in business, yet their aggregate production, measured in dollars and cents, has registered large increases every year.

Radio, like any other young industry that has grown by leaps and bounds, naturally must have its vicissitudes and its trials and tribulations.

Yet there are today many men who believe in the future of the radio industry; as can be easily demonstrated.

Those in the radio industry who shout from the housetops that there is no future for radio are, usually, those who have been unable to keep abreast of the times. This has been true particularly of many parts manufacturers who, lured by large orders from set manufacturers, have thrown overboard the radio builder and the radio experimenter by refusing to cater to them at all. In the meanwhile, they have taken factory orders at ruinous prices, and the radio set manufacturers have played the parts manufacturers against each other. This has resulted in the ruin of quite a number of parts manufacturers, who would have been far better off had they stuck to the custom set builders, the Service Men and the experimenters.

Even today, a number of these well-meaning, but misguided, parts manufacturers refuse to fill small orders from Service Men; although, we believe, there will be more business for the parts manufacturers from this source than from any other during the next few years.

This is a country of specialization, and in radio there is no exception to the rule. It has been found that those manufacturers and those business men who specialize in one thing usually have succeeded where others have not.

Each branch of radio today is so big that it should be exploited to the limit by itself.

It takes a tremendous amount of capital, a great deal of

knowledge, to turn out a large number of distinct lines; whereas if a parts manufacturer, for instance, limits himself to a few items, he will probably be better off in the end.

The short-wave field, for instance, shows very great activity today; and those who understand this angle of the radio art will surely cash in on it, heavily, during the next few years.

The same is true of television, which is just around the corner.

Recently a young man devised a new way of making a superior radio tube filament and, inside of a year and a half, he has amassed a small fortune from this single solitary item.

Another well-known concern in the business has for many years steadfastly refused to attempt to make everything under the sun. They have limited themselves to a single automatic resistor and have succeeded to a marked degree; although the item belongs to a declining group of radio parts.

Another well-known manufacturer, who is just now opening up a tremendous plant in New England with some 1,500,000 square feet of floor space, has made a huge success by selling kits of short-wave sets in this country and abroad.

The list is long, and many other instances could be given to show that specialization in radio today augurs well for the future.

And let no one think that the big radio companies are gobbling up all the small ones, or putting them out of business; nothing could be further from the truth. As a matter of fact, there are in this country today any number of smaller concerns who are doing very well, simply because they specialize in one or two items and, for this reason, are enabled to compete with the large concerns, by their smaller overhead and smaller expenses and their expertness in devoting all of their time and energies to the few items that they make.

As a matter of fact, it may be said that it is, today, much easier for the man of small means to break into the radio game than into any other line. Of course, this is true only of specialties and does not hold true for such items as sets and radio merchandise selling at higher costs.

There are so many different branches of radio and so many different items are required that, today, more than at any previous time, fortunes can be made from new radio items and improvements on existing ones.

The man who can give his close attention to some branch of radio, or to some single item, and who can keep up-to-date, will undoubtedly be able to cash in on his ideas and his energy during the coming years.

We have as yet not scratched the surface of the possibilities in radio; and those individuals who do not believe in the future of radio as others do should take stock of themselves and get in line or get out.

Modernizing the Old Receivers

The First of a Series of Articles on this Practical Subject

By R. R. MAYO

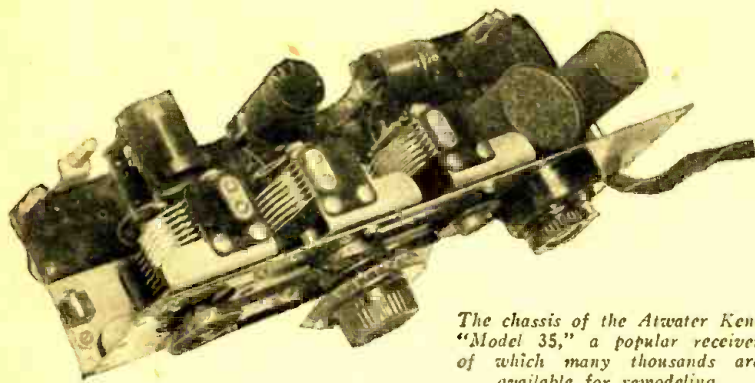

The chassis of the Atwater Kent "Model 35," a popular receiver of which many thousands are available for remodeling.

WHAT can I do with that battery set?" is often asked by the dealer who has taken it in trade. Also, a customer has frequently become attached to his old battery set and the manner in which it brings in stations; and he wishes to have it made all-electric, rather than change to an entirely new receiver.

Comparatively little thought has been given this by many Service Men. Yet everywhere there are dealers with basements full of battery sets which can be economically converted into efficient, full-electric operation receivers, and thus turned into money.

The writer has had a great deal of experience in this work and has, in fact, worked up a business in which parts made to his own specifications are used extensively. However, standard components, of the suitable values, may be used very satisfactorily.

In this article, the procedure of converting a six-tube battery receiver of a well-known Atwater Kent model is shown. The chassis is illustrated, and the schematic circuit of the remodeled receiver is given below. (The original circuit will be found in Data Sheet No. 17, in the May issue of RADIO-CRAFT; so it seems unnecessary to reprint it here.)

Rewiring the Filaments

The chassis is first taken from the cabinet; all connections to the "F" terminals of the sockets are removed, and all the grid returns are grounded. The detector socket is replaced by one of the UY type, to carry a '27 detector; the four-prong sockets will do for the '26s, to be used in the detector and

first audio stages, and the '71A in the power stage.

The sockets for the '26s are then wired together in parallel, with No. 18 wire, twisted in pairs (smaller wire should not be used, because of the heavy current drawn). The leads are then connected to the ends of the 1.5-volt winding of the power transformer,

THE most important thing to the Service Man, who is in radio for a living, and not for a hobby, is to obtain a good return for his skill and labor. Even the amateur, if he devotes spare hours to work for others, should consider that time is money.

What RADIO-CRAFT and its readers want is practical articles telling how money is being made out of radio service; for those which bring out really new ideas, that offer a profit to the Service Man, an extra rate will be paid. They should be accompanied by diagrams and good photos, if possible; as it is necessary to illustrate them for publication.

S1, which is to be center-tapped to ground through the 400-ohm resistor R2, which biases these stages.

Another twisted pair then connects the filament terminals of the detector socket to the 2½-volt winding S2; the center tap of this winding, and the cathode terminal of the UY socket, are both led directly to

ground. The power-stage socket is likewise connected to one of the 5-volt windings, S3; the center tap of this is brought to ground through a 2000-ohm resistor R3.

Volume control may be effected, in the new circuit, by the use of a suitable high-resistance potentiometer R4 (say 100,000-ohm maximum) across the aerial and ground, or of a 10,000-ohm variable resistor across the primary of the second R.F. transformer (shown in dotted lines). The use of a rheostat in series with the filament of an R.F. tube is not recommended, because of the filament's characteristic of "thermal lag"; though this method has been used in commercial receivers.

The "ABC" power transformer, of one of the types readily obtainable, will have also a suitable high-voltage winding S4 for the '80 rectifier tube, the filament of which is lit from the last of the low-voltage secondaries, S5.

The Plate Supply

The filter may comprise one or two chokes; but two are to be recommended, with the highest voltage tap taken from between them, as in the diagram. The conventional condenser block of eleven or twelve microfarads capacity, 400-volt working rating, may be used, adapted as shown in the diagram. The voltage divider should have about 18,000 ohms resistance; it is important that the taps should be readily adjustable, so that the settings giving the proper voltages to the tubes may be made. This is especially important in the R.F. stages; for,

(Continued on page 44)

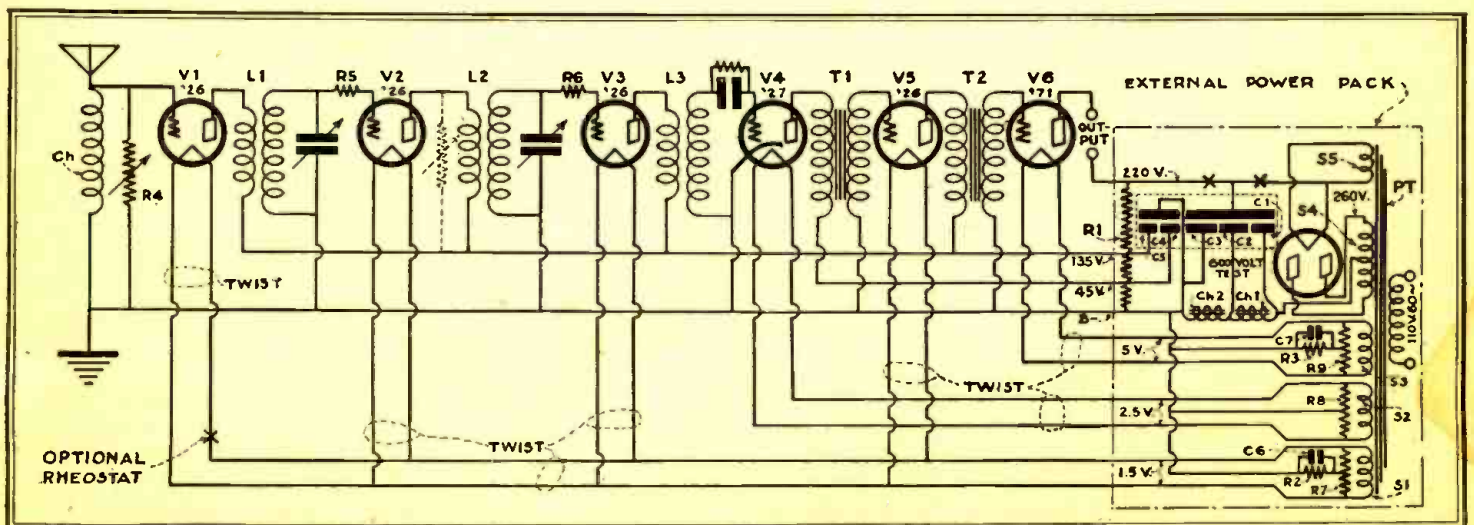

The circuit diagram of the six-tube Atwater Kent receiver shown above, as it appears after remodeling for electric operation, with the addition of a power pack providing filament as well as plate current. The changes are simple, and entail a comparatively small expenditure for components. (Compare with Service Data Sheet No. 17, in May RADIO-CRAFT.)

Leaves from Service Men's Note Books

The "Meat" of what our professionals have learned by their own practical experiences of many years

By RADIO-CRAFT READERS

REDUCING INTERFERENCE

By Michael Janosko

STATIC reduction by the method which Mr. Turenne described, on page 295 of RADIO-CRAFT for January, has been found successful by several Service Men of my acquaintance. Others have been helped by the method which I relate below.

A special call took me to a suburb, some miles away, to service a Victor set which had been delivered two weeks ago to a location which previous Service Men reported good. Despite their efforts, complaints flowed in, and the customer had stopped payments until the set should be properly serviced. As I knew my predecessors were good men, I had little hope of success.

The set was located in a two-story frame house on a hilltop, in a section where electric refrigerators and such sources of interference were seemingly scarce—except for a street-car barn some few blocks away. I

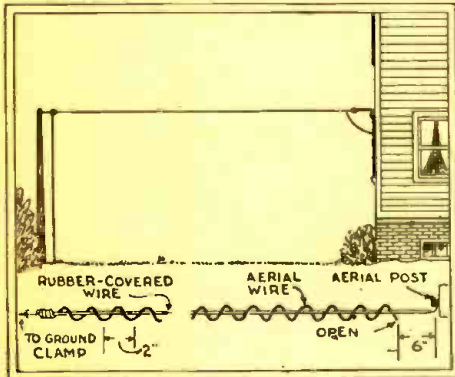

Fig. 1

One method of dealing with interference problems which will work in some locations. In some cases, the simpler method of grounding the far end of a long aerial will work.

questioned the owner as to the behavior of the set and, with her answer ringing in my ears, attempted to bring in local stations. Five minutes later I was convinced that the situation was hopeless; powerful local signals were mangled by an incessant frying, hissing, crashing and jangling noise. WTAM and WLW could be tuned in; but only by listening hard could a word or a few bars of music be distinguished above the noise. Yet the set was in perfect condition and the aerial and ground were no worse than others that brought in Cuba and Florida on the same model.

The car barn should not cause all the noise; because I had installed a Philco much closer to the barn, and the noise level was very much lower. Still, you never can tell. I connected a temporary aerial to the set and, by moving it in different directions, convinced myself that the aerial was not at fault.

I sat on the porch in the cold, smoking and meditating. My experiments had

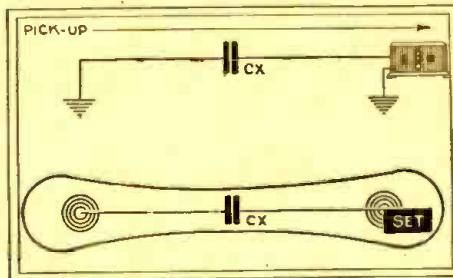

Fig. 2 (above) Fig. 2A (below)

The antenna illustrated in Fig. 1 amounts simply to a condenser between aerial and ground. It is highly directional in the line of its length.

showed just one thing: the higher the aerial was raised, the greater the noise. An underground aerial would seem to be just the thing; but it was impossible, for various reasons, to install one here. As a last attempt, I decided that, if I couldn't put the aerial underground, I'd raise the ground to the aerial. It worked!

Here's how I did it: I took sixty feet of aerial wire from my kit, then thirty feet of No. 10 rubber-covered wire. One end of the latter was connected to the aerial binding post, and led through the window in the ordinary way. Over this I wrapped the aerial wire, spacing the turns about two inches apart. The other end of the aerial was then grounded, as the diagram (Fig. 1) will show, to a good ground. This resulted in a decrease of both signal and noise, without decreasing the ratio between them; when the volume control was advanced, we were back where we started. One end of the aerial wire must remain open, and one end of the rubber-covered wire must remain open; there is no conductive connection between them. The virtual schematic circuit is Fig. 2.

I have installed at least a score of such antennas since then; they will not always work. The best thing to do is to carry one already prepared, and experiment with it. The pick-up with an aerial of this type is greatest in the direction of the lead-in, thus reducing static from other directions (Fig. 2A). Its height may be anywhere from five to fifty feet above the ground.

A HANDY SERVICE LAMP

By Joseph Leeb, E.E.

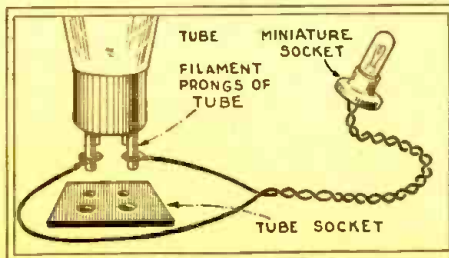

Fig. 3

A very simple method of operating a tiny trouble lamp.

TROUBLE shooting is made easier by the use of a miniature lamp and socket and a few feet of twisted wire, the ends of which are made into loops and soldered. These eyelets may be slipped over the filament prongs of the '80, or other tube of suitable voltage, and current to light the lamp is thus obtained. This trouble lamp, being so small, can be dropped down into places inaccessible to an ordinary flashlight. (Fig. 3.)

A RADIATOR ORNAMENT

By Marlin H. Thurmond

DESIRING an appropriate novelty for my radiator cap, I removed the old one, and (using a tube-base template, which nearly every Service Man has in his junk box) I drilled the necessary holes in the cap and inserted a shiny, silvered '01A

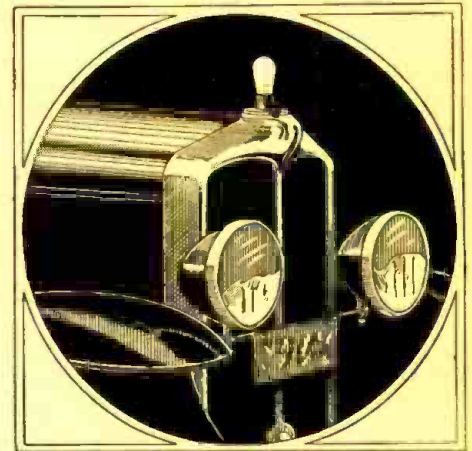

Fig. 4

Mr. Thurmond ingeniously displays the sign of his profession, like this. With burnt-out tubes, replacements should be cheap—and disappointing to thrifty neighbors.

tube. If the holes are not drilled too neatly, the tube will press in tightly and require no other fastening.

It is our belief that periodicals of the type of RADIO-CRAFT are invaluable to Service Men who utilize their contents to the best advantage. This organization finds it advantageous to have a separate file, in which each service note or schematic circuit of value is filed under the proper heading.

PUTTING BACK THE LOST CONTROL

By Paul McDonald

ONE of the weakest points in a great many single-control sets is the method of coupling the antenna to the grid of the first tube through an untuned stage. Why anyone would build a set in this manner is beyond me. (That's easy.—Editor.)

In a receiver already constructed, it is almost impossible to change this without a great deal of trouble. The method shown in the diagram (Fig. 5) will work out very well, and add a kick to reception without much expense. It will add somewhat to the

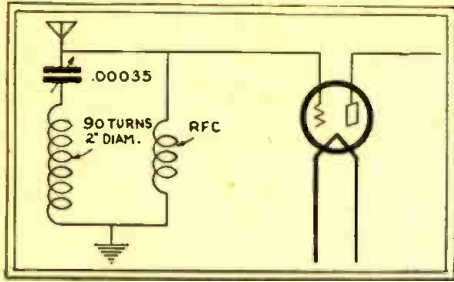

Fig. 5

The series-tuned coil shown in the diagram bypasses other frequencies, more or less, and introduces additional selectivity.

selectivity of the set and will not make it critical. It is, roughly speaking, merely a high-loss tuned antenna circuit, and requires an additional coil and condenser, as shown in Fig. 5.

In the 'M.B. 29' kit a change can be

made which will work wonders. Remove the radio-frequency choke across the antenna and ground, and substitute a variometer, such as the General Radio "Type 269," in its place. This part may be mounted on the panel with a knob to match the National dial supplied with the kit. Then you may hear a set perform as it should. (Fig. 6).

(The reason for the untuned stage and its lowered efficiency is to create the single-control selling argument for customers who know nothing of radio. Then, after a time, the radio owner who wants distance is willing to pay extra for the added control.)

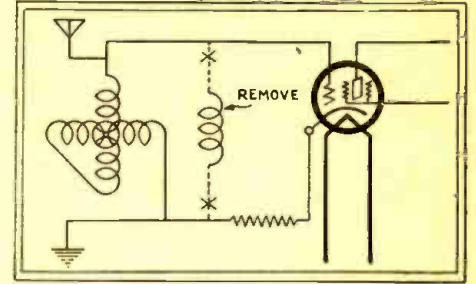

Fig. 6

The removal of the aperiodic antenna coupler is more effective; if it can be effected. A variometer is then put across the antenna.

SHOWMANSHIP IN SERVICING

By Anon

SERVICE calls may require more tact and psychology than radio knowledge. I was called by a complaint of a noisy volume control in a Stromberg-Carlson with an external magnetic speaker of the same make.

The system of control was dual: a potentiometer of about 25,000 ohms in the antenna circuit and a variable resistor of 25,000 ohms in the plate circuit of the third R.F. stage. The latter was by-passed; so I turned to

(Continued on page 46)

Service Hints on Some Popular Receivers

By HAROLD WEILER

OFTEN a source of hum, in the Atwater Kent "36," "37," "38," "40," "42," "44" and "52," is a faulty connection between the bolts in the power pack and the terminal strip, especially that shown by X in Fig. 1. The connection may have been tight enough originally; but the heat of the transformer has caused the bakelite to expand enough to loosen our formerly good connection. It is advisable to go over all of them with a pair of pliers.

In the Atwater Kent "Model 37" the filter condensers, as shown as A and B in Fig. 2, may burn out; a symptom of this is overheating of the rectifier tube, due to the extra load which is imposed on it by the shorted condenser. In the new A. K. direct-current set, audio-feedback howl may occur; great care should be taken to see that the '12A tubes in the detector and first audio sockets are non-microphonic. It is sometimes necessary to install a heavier howl-arrestor than the one regularly furnished.

When sets have been in use from nine months to a year, they may lose their pep. A few Service Men then resort to the method of lining up the condensers correctly; at the factory these were purposely set a bit out of line so that the set would be easier to stabilize. This is not noticed while the installation is new and at top-notch efficiency; but later becomes obvious.

If you find terrible hum when a station is

tuned in, and excessive hum when the set is not in resonance, suspect an incorrect bias on an audio tube—especially in the Sterling power pack of a "Radiola 41." The condenser A (Fig. 3) may have broken down. In an emergency, just clip one lead of the condenser; from a service standpoint, another must be installed.

The "Radiola 32" power pack has a 65-volt primary; the other 50 volts are dissipated by the 886-type ballast resistor. In the "Radiola 50," the grid suppressors are 1000-ohm, as in the "17" and the "41."

A loss of volume, and no distance, on the "Radiola 20," accompanied by lack of response to the trimmers, indicates a bad connection to the rotors of the condensers. Some good pigtail wire will do the trick.

If a "Radiola 44" or "46" oscillates, and changing tubes does not help, see whether the stage shields are not loose. If they are, and tightening does not help, take the chassis and pack out of the cabinet, and place them at the same distance that they usually are separated. You will find on the front of the assembly three flat-head screws to adjust trimming condensers which may be used to stabilize the receiver.

Noise in "Model 72" and "92" Majestic may be due to thumb nuts which have been tightened only by hand, and have become loose on account of vibration caused by the fact that the dynamic is on the same shelf as the power pack.

Noise in a 1929 Eveready may be due to the looseness of the set screws on the variometer; if the set oscillates, look at the stage shields.

If the analyzer shows no plate voltage at the detector or first A.F. socket in a Temple "Model 8-60," "8-80" or "8-90," we know the transformer primary is burnt-out. This is the second terminal strip from the left (with the set upside down and back facing us). The same is true of the screen-grid models. All of these models with a serial number under 7500 have the pilot light across the '27 filament leads; if you will change it to take current from the '45 leads, you will stop a noticeable flicker.

The usual call on a D.C. Temple is to replace the '71A tubes, which burn out very quickly under excess line-voltage. A cheap method of overcoming this is to put a 400-ohm grid suppressor R across the filaments, which are four in series, as shown in Fig. 4. This will cause a small voltage drop.

In the Colonial "31DC," the burning out of the condenser which is in series with ground will make the "on-and-off" switch useless. As long as the line plug is in the wall socket, the set will operate if this condenser is shorted. To verify this, disconnect the ground, and the set will stop. Slide the set out, turn it on its back, and disconnect the assembly of three condensers at the farthest left (with back of set toward you.)

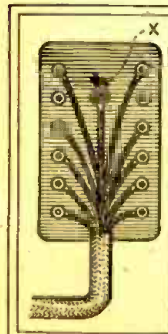

Fig. 1

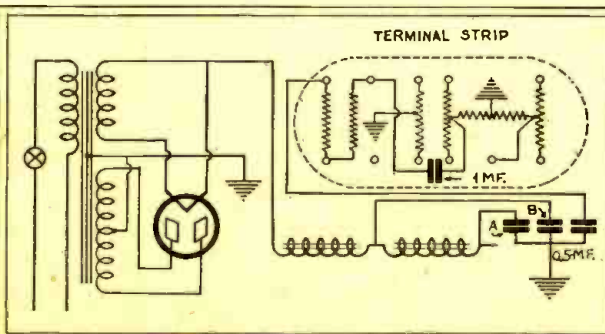

Fig. 2

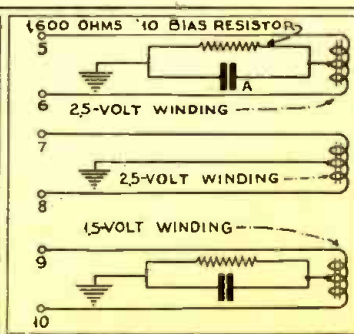

Fig. 3

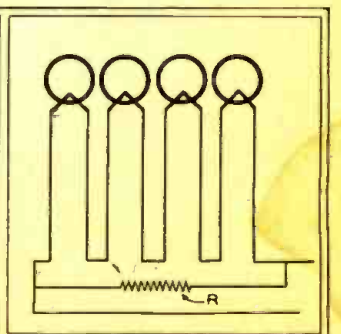

Fig. 4

At the left, a view of the terminal strip attached to many Atwater Kent power packs. Connections here should be tightened. In later models, the filter condensers A and B (Fig. 2) should be checked if an '80 goes out. In the Sterling pack, check the by-passes of the biasing resistors (Fig. 3). In a D.C., with tube filaments in series, excessive line-voltage conditions cause short tube life. A shunt resistor, as shown at the right, will safeguard them.

A Vacuum-Tube Multi-Meter

An instrument for the Service Man or experimenter which measures current to 100 milliamperes, voltages to 500, amplification gain, resistances and large inductances

By BERYL B. BRYANT

A GREAT deal has been written about the vacuum-tube voltmeter, covering its theory of operation, usefulness and constructional data. Much of what was written is by the radio engineer and for the radio engineer; the language is couched in technicalities, and difficult for the average radio experimenter and radio set builder to understand completely. Such

standard. The latter measurements include those of the output impedance of amplifiers, and the input impedance of loud speakers, at any desired frequency. Numerous other measurements may be made which are not listed here.

Material Needed

For the construction of this instrument the following parts were utilized:

- Two Carter filament switches, Midget type (F) (E);
- One 400-ohm potentiometer of rugged construction (P);
- One Carter Midget 25-ohm rheostat (R3), and a .06-ampere filament ballast, (R2);
- One UX-99 tube, and socket (VT);
- One Electrad 2000-ohm "Type B" Truvolt resistor, (R5);
- One Electrad 50,000-ohm Type B Truvolt resistor (R4);
- Eleven Yaxley cord tip jacks (AC1) (HT) (HT1) (VT) (VT1) (M) (N) (L) (MA1) (MA2) and (MA3);
- Five Pilot plain bakelite binding posts (B1) (B2) (B3) (B6) (B7);
- Two Pilot bakelite binding posts with A.C. designation (B4) (B5);
- One Sangano .002-mf. molded mica condenser (C1);
- One bakelite or hard-rubber panel 13½ by 5½ by 3/16 inches to fit top of utility chest or box;
- One "Utilco" pressed steel tool chest 14 by 6 by 6½ inches, outside;
- Four 22½-volt portable "B" batteries;
- Four standard 4½ volts "C" batteries, one for filament supply;
- One cord tip (CT);
- One piece bakelite 2 inches square; fourteen 4-32 brass machine screws; two pieces heavy spring brass, or phosphor bronze, strips ½-inch wide by 2 inches long, 1/4-inch shaft 2¾ inches long. At one end of the rod, 5/8-inch should be turned down to 1/8-inch diameter and tapped for 6-32 thread. One piece copper or brass 1¼-inch square. These parts are used for special switch assembly. (A-B-C-D.) A new Yaxley "Bi-Polar" switch, which has since become available, may be used instead.

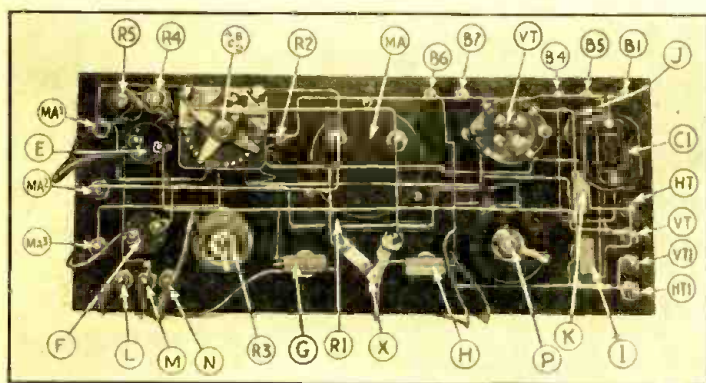

Fig. B

The panel of the Multi-Meter as it appears from the under side, showing all the instruments and wiring. The multi-point switch ABCD must be made by the constructor; the others are standard, and the workshop will undoubtedly afford most of them.

knowledge, although desirable, is not necessary in order to construct and use such a device. The fault with many of the instruments described has been that they are intended for special tests and are not sufficiently versatile and self-contained for the average experimenter's use. It is also true that they are of great accuracy—and very costly as well.

Herewith is presented a vacuum-tube voltmeter for the Service Man, the dyed-in-wool radio experimenter, and the set builder. It is easy of construction and is inexpensive, considering the multitude of work that may be accomplished with it. Its accuracy (within limits of course) depends upon the accuracy of calibration. It is of such size that it is easily portable, making it a useful testing instrument for testing the voltages of both A.C. and battery-operated radio receivers, as well as "B" power units, within the range of the instrument. In this respect it is interesting to note that, because of the very high resistance between the elements of the tube, when the instrument is placed in shunt with a device to be measured, practically no current is consumed.

The instrument will measure either A.C. or D.C. voltages from 0 to 10, 0 to 100, or 0 to 500. The milliammeter shunts provided allow the measurement of plate currents between 0 and 100 milliamperes. For this purpose three scales are provided: 0 to 1, 0 to 10, and 0 to 100. By the proper arrangement, the amplification gain of both R.F. and A.F. coupling devices may be determined and the amplification gain per stage, or as a whole, of any R.F. or A.F. amplifier may be measured. Unknown impedances or resistances may be measured, or compared against a known resistance

- One Weston "Model 301" 0-to-1 scale milliammeter (MA) (Many experimenters have on hand a R.F. 0-to-110 scale thermogalvanometer whose thermo-element has been burnt out or broken; this would make a suitable meter for use in this device. This instrument, without thermo-couple, has a full scale deflection of 0.75-milliamperes.) Whichever instrument is used may be provided with a 0-to-10 volt scale, as shown here, although this is not necessary;
- Two Hart-Hegeman S.P.D.T. snap switches (H) (K);
- Three Hart-Hegeman S.P.S.T. snap switches (G) (I) (J);

Fig. A

The Multi-Meter mounted in a steel tool chest, used by Mr. Bryant for the purpose, which contains also the necessary batteries for its operation. A circuit diagram and calibration chart, mounted in the lid are convenient for reference. They are reproduced on pages 14 and 15.

The heart of the apparatus is of course the meter M.A. The instrument used should be one of known accuracy; its type and scale reading may differ from that shown, with corresponding change in the calibration. The lettering is explained in the text.

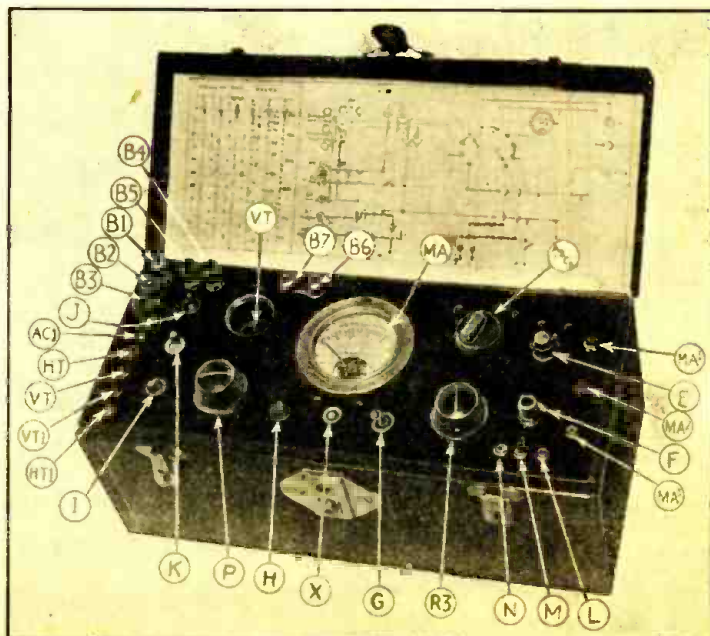

Assembly

The panel is first cut to exact size, to fit just inside the flange of the tool chest; right-angle brackets are soldered to the inside of the chest, 3/16-inch below the top edge. These are to support the panel; six should be used, two at each end and one in the center on each side. This placement will insure proper clearance from the instruments mounted on the panel. The panel is then laid-out, using the general arrangement shown in the illustrations.

As a great deal of space was not available, it was necessary to make the special switch as small as possible; the assembly is seen in Fig. B. The square 2-inch bakelite strip is now scribed for a 1 5/8-inch circle. 170 degrees of this circle is divided into divisions for the 14 switch points. The center of the piece is drilled, to pass the turned end of the 1/4-inch shaft; the switch-point holes are also drilled and tapped for 4-36 screws. After dipping the 4-32 screws into shellac, they are forced into the 4-36 tapped holes in the bakelite, this procedure will firmly anchor them. Before proceeding, the holes for the support pillars should now be drilled in the rear corners of the bakelite switch plate. The triangular contact plates should be cut to shape, and are secured in position by the same screws that fasten the bakelite to the support pillars. On the side of the bakelite piece which carries heads of the contact screws, (counting from the first screw on the right, with the contact plates held at the bottom) the second, fourth, sixth, ninth, eleventh and thirteenth screws are cut flush with the bakelite. These spacing screws are used to prevent shorts between live points when the

switch blades are rotated. The heads of the remaining screws serve as soldering contacts. The length of each screw on this side should be about 1/4-inch, including the thickness of the head.

The switch blades should then be cut to shape and drilled to take 1/4-inch insulating fibre or bakelite washers. Before assembling the blades on the shaft, the contact sides of the screw switchpoints should be filed down to an even height of 1/16-inch. The burrs should be removed from the edges of the screws, to prevent scraping the switch blades.

The brass shaft is then placed through the switch plate, after placing a thin brass washer over the threaded shank to prevent wear of the bakelite. After the shaft is through, a 6-32 nut (not more than 1/16-inch thick) is run over the threaded part, but not so tight as to prevent rotation of the shaft. A large insulating washer, 1/2-inch in diameter, is placed over the shank; then a switch blade and its inner 1/4-inch washer insulator; another 1/2-inch fiber washer; the other switch blade and its 1/4-inch washer; a brass washer and tightening nut. Before tightening the switch-blade assembly, set one switch blade on contact pin No. 1 and the other on pin No. 8. Then tighten firmly. Place on an additional nut to prevent loosening of the assembly. A pin, which prevents the blades rotating past their points, is necessary. The switch assembly is then fastened to the bakelite panel.

The "Short" switch ("X") is next made. This is made from the springs of an old phone jack and is arranged to close contact until pressed. A knob protrudes through

the panel. This is a detail easily worked out by the constructor.

The instrument is now wired with bus-bar; flexible hook-up wire is not used, because of the possibility of disturbing calibration. The joints should be well soldered and, after the assembly is wired, flexible leads for the batteries (which are strapped to the bottom of the case) are soldered to their proper terminals.

Calibration

If the builder does not care to send this instrument to one of several testing laboratories for calibration, he may calibrate the instrument in the following manner.

Before the batteries are connected, the shunts are made for the milliamperere scales.

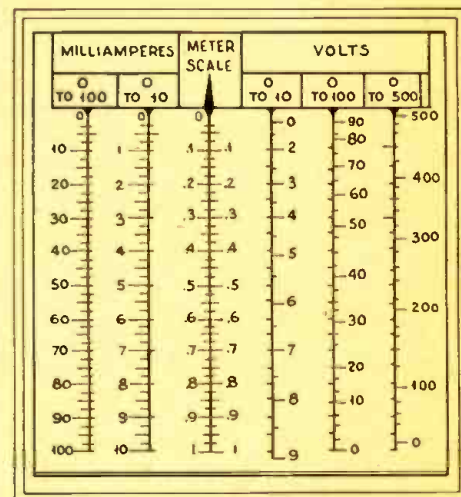

Fig. 2

The current readings are simply multiplied, but the voltage readings are reversed. A table of this kind should be made to calibrate the Multi-Meter.

Table I

TO MEASURE	SWITCH POSITION	SWITCH POSITIONS								JACK POSITIONS				SHUNT "S"	CONNECT TO TERMINALS	"SHORT" SWITCH	REMARKS
		E	F	G	H	I	J	K	L	M	N						
Milliamps. 0-1.0 scale	D	off	off	off	max.	off	off	B1	off	off	off	off	off	Ma1 & Ma2	open		
Milliamps. 0-10.0 scale	D	off	off	off	max.	off	off	B1	off	off	off	off	off	Ma1 & Ma2	closed		
Milliamps. 0-100 scale	A	off	off	off	max.	off	off	B1	off	off	off	off	off	Ma1 & Ma3	open		
Volts (A.C.) 0-10 scale	B	on	on	on	max.	off	short B1 to B2 for test	B1	on	off	off	off	off	Vt & Vt1	open		
Volts (D.C.) 0-10 scale	B	on	on	on	max.	off		B1	on	off	off	off	Vt & Vt1	open	(Note E)		
Volts (A.C.) 0-100 scale	C	on	on	off	either	close	off	B1	off	on	off	off	B7 & B71	open	(Note F)		
Volts (D.C.) 0-100 scale	C	on	on	off	either	for	off	B1	off	on	off	off	B7 & B71	open			
Volts (A.C.) 0-500 scale	D	on	on	off	either	zero	off	B1	off	off	on	off	A7 & B71	open			
Volts (D.C.) 0-500 scale	D	on	on	off	either	test	off	B1	off	off	on	off	B7 & B71	open			
Impedance or Resistance (Unknown)	B	on	on	on	max.	off	on	B3 to B1	on	off	off	off	close R. P. test	(Note C)	open	(Note G)	
Gain (Note A)	B	on	on	on	max.	off	on	B1, B2 & B3	on	off	off	off	close R. P. test	(Note D)	open	(Note H)	
Gain (Note B)	B	on	on	on	max.	off	on	B1, B2 & B3	on	off	off	off	B1, B2 & B3; see Remarks		open	(Note I)	

Note A. R.F. or A.F. gain per stage, or entire amplifier, or output of A.C. voltage generator.
 Note B. Gain of A.F. stage-coupling device, with current in primary.
 Note C. Connect unknown to B2-B3; graduated resistance box to B1-B2; A.C. supply of desired frequency to "A.C." posts.
 Note D. Connect input to B1, negative return to B2, output to B3.
 Note E. If measuring R.F., close shunt "S" of by-pass condenser. Multiply meter reading by 1.414.

Note F. Multiply meter reading by .707 for effective volts.
 Note G. Throw "K" to B3 position; take reading; throw "K" to B2 position. Vary "decade" resistance until same meter reading is obtained. Read value of impedance of resistance direct from resistance box. Inductance is calculated by the voltage, current and impedance formulas.
 Note H. Make readings of B1 and B2; subtract difference.
 Note I. Refer to N.E.M.A. Radio Standard for circuit and external apparatus used in this test.

The 0 to 10 (R1) shunt is made first, by using a 15-inch length of No. 34 or 36 copper (insulated) wire. This is soldered between one side of the "Short" switch and the "-" side of the meter; the other side of the "Short" switch having previously been connected to the "+" side of the meter and MA2. After connecting in series with the meter to be calibrated an external milliammeter of suitable scale, a Clarostat or similar resistance, and a dry cell or storage battery, the length of the wire shunt is varied until both meters give a 10-milliamperere deflection. The wire is then wound on a small round stick, non-inductively. (Double the wire back on itself and wind as a single strand.) A drop of sealing wax will anchor the stick, to protect the wire joint. The multi-point switch is now placed on position "A."

When calibrating or measuring potentials above 10 volts, it will be noted that the vacuum tube VT is connected up "backwards," to indicate the "grid current" on MA. That is, MA is connected in the grid circuit of VT and the voltages to be measured are applied to the plate of VT. A little reflection will show that a positive potential of, perhaps 50 volts, would apply a difference-potential of about 35 volts, positive, to the grid of the '99 if the circuit remained as connected for current up to 10 volts; thirty-five volts positive on the grid of VT would ruin it.

The shunt for the 100-ma. scale should

be made similarly to R1. This is connected across the "A" points of the multi-point switch and designated as "R2."

After the shunts are made, the batteries are connected and the tube inserted in the socket. The bi-polar switch ABCD is placed on position "A," and switch (E) closed. The rheostat is adjusted until the meter, shunted by R2 only (switch X pressed "open"), indicates the filament requirements of VT, or 60 ma. *This must be done before making any future measurements, in order to maintain a fixed standard.* Proceed by rotating bi-polar switch to points B; next close switches (F), (G), (H on "C-9"), (J), (K on B1 side); connect cord tip CT to "B+90" tip jack, and strap binding post (B1) to (B2). Then put MA into circuit on the 0-1-ma. scale by pressing (X), and adjust potentiometer (P) until meter reading drops to .05-ma. On the 10-volt scale this setting is always taken as the zero point, and the Multi-Meter will be functioning as a true vacuum-tube voltmeter, indicating an increase of plate current from .05-ma. upward; as positive potentials up to 10 volts, on the grid, counteract the negative bias necessary for a zero-point plate reading of .05-ma. An A.C. transformer of 12- to 14-volt secondary is shunted by a 400-ohm potentiometer, the arm and one side of which are connected to (VT) and (VT1). An A.C. voltmeter of suitable scale is connected across the same terminals. Beginning with 1/4-volt on the A.C. instrument, vary the external potentiometer in 1/4-volt steps, taking down the reading of MA. This procedure is carried out over the entire 10-volt scale.

To calibrate the 0 to 100-volt scale, shift multi-point switch to position "C." Place the cord-tip lead in "B" battery jack (M). Close switches (E) and (F). Open switches (G), (H) and (J) and set (K) at (B1).

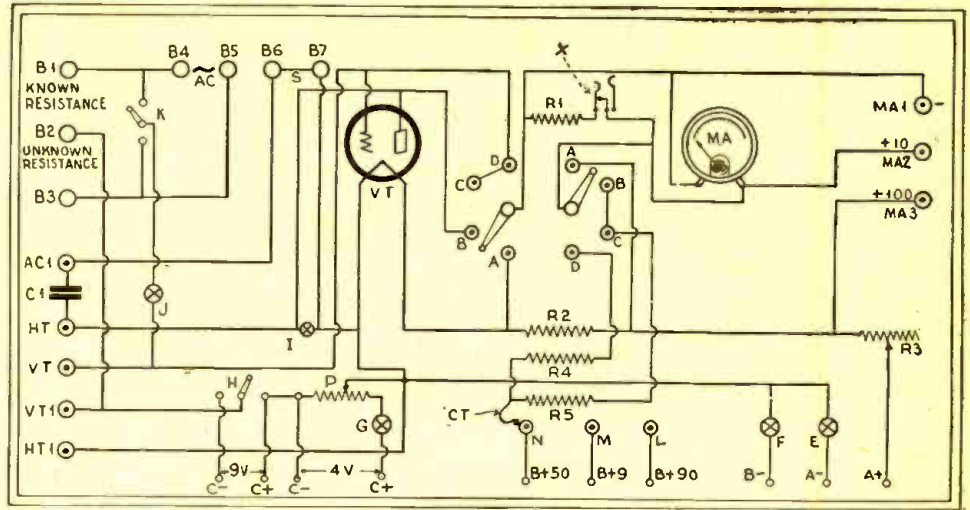

Fig. 1
Schematic circuit of the Multi-Meter. Jumper S is seldom used, as indicated in Table I. The two blades of the bi-polar switch ABCD rotate together. C1 is a D.C. blocking condenser or a by-pass condenser, depending upon the test. Filament current of VT must always be 60 ma.

Open the by-pass-condenser shunt (S). The tube should previously have been set to draw just 60 milliamperes on the filament, using the multi-point switch position "A." Close switch (I) to get the "full-scale" deflection of the meter ("X" open); this establishes the Zero for this scale. Now open switch (I); as the calibrating voltage applied to (VT) and (VT1) is increased, the meter deflection will be downward or toward the meter zero point. In other words, for the maximum measured voltage the meter indication will be near zero. Using any source of direct-current supply and a D.C. voltmeter of suitable scale, connected with its "+" to (HT1) and its negative side to (HT), the voltage is varied as before, but in steps of ten volts. The calibration meter need not be of the 1000-ohm-per-volt

grade, but it should be remembered that the accuracy of the multi-meter depends on the accuracy of the calibrating meter. The "Short" switch is used in making the reading, as described before.

For calibrating the meter to the 0 to 500-volt scale, the positions of the switches are the same as used for the former scale; with the exception that the multi-point switch is placed on position "D" and the cord tip in jack (N). The high scale may be used also for measuring high-tension A.C. voltages in the same manner, but using the jacks (AC1) and (HT1) with alternating current on the terminals. Calibrate in 20-volt steps. Assemble various calibrations on a single scale, as in Fig. 2.

The accompanying table (1) gives the procedure of taking measurements.

Who Has the Right to the Patent?

A Point of Law Important to the Inventive Service Man

By J. HAROLD BYERS

"I AM an inventor. I have devised a new and useful improvement in radio receiving sets during the course of my employment with the X Manufacturing Company. Who is entitled to the patent, they or I?"

The law on this subject is much racked and little understood. Violent controversy has entered into the matter on both sides. However the legal chaos is resolving itself at last into the following well-defined policy:

According to the best authorities, where the employer does not have an express contract, as a part of the contract to hire, the patent belongs to the employee and to nobody else; although the employer may have what is legally known as a "shop right."

In other words, in the absence of an express contract, the X Company, or any other company, cannot appropriate the patent rights to that which another person has invented; and this regardless of whether he is an employee or not. However, the employer may use the device and this use is known as the "shop right." The inventor retains the right to dispose of his patent as he sees fit. He may sell the right to make, use or sell, to any other manufac-

turer. His own employer simply does not have to buy the right to use.

From the employer's standpoint it is clearly good practice to see to it that each employee sign a contract conveying patent rights for a stated stipulated sum.

In the decision of Haggood vs. Hewitt (119 U. S. 226) it was ruled that where the inventor has been hired to invent generally, the employer may have a licence. According to another decision (137 U. S. 342), in the absence of an express contract or specific employment to invent, the employer has only a "shop right" or an irrevocable right to use the invention.

It is the general rule that an invention belongs to the man who invented it; this right is not alienated by the fact that he happens to be hired. But it is an equally general rule that the product of employed labor belongs to the employer. When an invention is the product of employed labor, what is the answer?

The courts find themselves in the quandary of protecting the rights of capital and labor in one and the same instant. The result is a compromise—albeit a very fair one. They decide that the employer should take his

share—the right to use the invention; and that the inventor should take his—the right to sell the patent.

Moreover, under no circumstances can anybody but the real inventor apply for or take out a patent. Whatever rights in it may come afterwards, the original right to secure a patent is his and his only.

It is believed that no more adequate illustration of the employer-employee relation could be found than that arising in connection with the hiring of F. W. Dunmore by the U. S. Bureau of Standards. To be sure the decision relates specifically and particularly to government employees; but it relates with equal force to the thousands of employees throughout the country—the thousands of mechanics, technicians, and scientists with inventive turns of mind. The principles are broad.

Adhering to the principle laid down by the Third Circuit Court of Appeals (Sept. 13, 1927) the United States Court for the District of Delaware decided that neither Mr. Dunmore of the radio section of the Bureau of Standards, nor any other em-

(Continued on page 48)

Operating Notes for Service Men

Mr. Freed follows the excellent idea of keeping a notebook and jotting down his experiences with sets of this and that model. Consequently, he has a "line" on many of them which saves time and worries.

By BERTRAM M. FREED

SERVICE MEN experience much trouble from microphonic sets in which the condition persists even after all tubes have been replaced. It will be found, usually, that the fault lies in vibration of the cabinet and chassis. Bracing the cabinet by means of wooden strips, properly applied, has been successful in reducing the condition to a minimum (Fig. 1).

In many cases, it will be necessary to float the chassis on rubber and felt; Radiola and Brunswick have prevented this trouble by mounting the receiver and the power pack on resilient rubber cushions. Sometimes, mounting the speaker on rubber has corrected microphonic conditions.

However, the annoyance may persist even

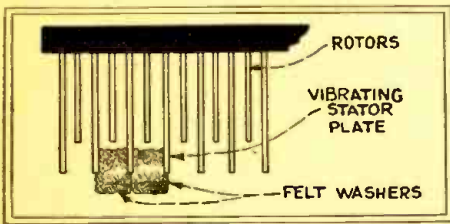

Fig. 2

Instead of the tube, the variable condenser plates may require damping, as shown, with soft material.

after these changes have been made; in which case the fault is probably in the plates of the variable condensers; certain frequencies will set these in vibration, causing microphonic conditions. The writer has found this condition in sets on which much time and money had been spent. It is not difficult to locate the condenser; set the set in operation to obtain the howl, and touch firmly each plate with a hard rubber rod. The howl will disappear when the bad one is reached. The vibration is remedied by inserting small felt "piano washers" between the troublesome plates (Fig. 2).

Many sets, when on the point of resonance, will set up a loud hum in the speaker. This has almost invariably been cured by inserting a condenser of one microfarad, or higher capacity, between the "B—" of the set and one side of the light-line (Fig. 3).

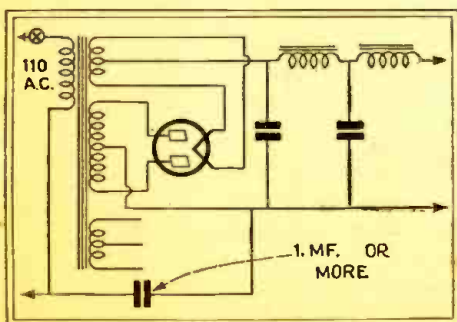

Fig. 3

The capacity indicated will often by-pass to ground an unpleasant hum. It should be of proper rating.

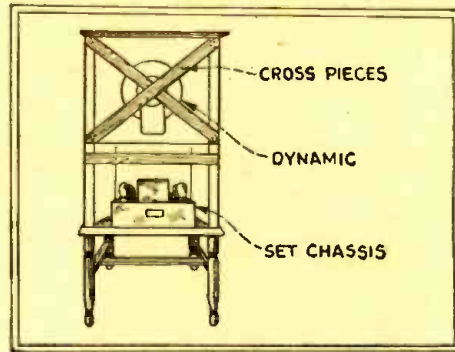

Fig. 1

The use of cross pieces is one way to suppress microphonic noises, due to vibration.

Complaints of noise have often been overcome by a little experimenting with the aerial system. The writer has successfully used two aerials, diverging at an angle from the lead-in (Fig. 4). The best position, in which noise pick-up is balanced out, must be found by trial. Up to this writing, this method has been found very satisfactory in five installations, all in bad locations.

Radiolas and Brunswick Models

In the "Radiola 62," bad hum may be traced to the dry-disc rectifier (energizing

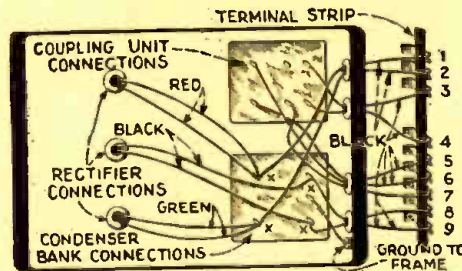

Fig. 5

High-resistance joints are a source of trouble wherever found. They may be suspected at the points shown (X).

the field coil of the dynamic reproducer) which works directly from the 110-volt A.C. line. Failure and weakening of the "stacks," of course, will cause this hum; but, if the rectifier tests perfect, look to the soldered connections in the power pack (Fig. 5). Cold-solder joints here will create abnormal hum.

In Radiola and Brunswick radio-phonos which have a '71A audio stage, there are five terminals for phonograph connection. The phonograph cable is too short to permit removing the chassis for repairs or balancing; but it may be disconnected and its terminals shorted in the manner shown in Fig. 6.

In all Radiola and Brunswick superheterodynes, the black ground wire must never be connected to the metal frame of the chassis from which it is led; as this will make the set inoperative. The correct method of

adjusting the oscillation trimmers and the R.F. compensating condenser in these receivers is as follows:

The oscillator trimmer (at the right, as you face the back of the set) should be adjusted for loudest response to a station when the dial is set between 10 and 15; the trimmer at the left should be adjusted for loudest response with the dial around 80. In sets equipped with a tuning meter, these trimmers should be adjusted for greatest swing on the meter. The R.F. compensator should be adjusted on a low-wave station, with the volume and sensitivity controls full on. The compensator should be tightened, and then loosened till just beyond the point of oscillation.



Fig. 6

On removing Radiola-Brunswick chasses for balancing, short the terminals shown during the operation. (This applies only to models using a '71A stage.)

Other Makes

In earlier Sonora models, using the Loft-in-White R.F. amplifier and 15-volt tubes, there is a rheostat connected in one side of the R.F. tube filament circuit; it will be found at the bottom of the R.F. chassis, behind the tuning dial.

The pitch of Bosch "Model 28" and "29" speakers may be varied by changing the value of the resistor (50,000 ohms normally) which reduces the R.F. voltage to provide a detector plate tap (Fig. 7). Cases of motorboating and audio oscillation in this model have been cured by an added condenser between the high-voltage side of this resistor and "B—."

In the "Zenith 50" series, an evasive bad (Continued on page 46)

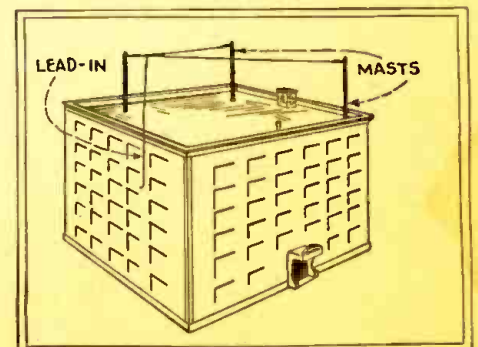

Fig. 4

In some localities, a certain local interference may be overcome by experiments with a double aerial.

The Service Man's Open Forum

SMALL-TOWN SERVICE NEGLECTED BY INDUSTRY

Editor, RADIO-CRAFT:

I have been in service work for seven years in a small town of about a thousand population; there are others within a radius of ten miles, and farmers nearby who have sets. From these sources, I am able to draw, and I usually have plenty of work on hand.

The point I am driving at is, that we must consider the difference between the city and the smaller towns. There are hundreds of these hamlets to one city; and a large number of radio sets are owned by small town and farm people. I think these people should have more consideration from the manufacturer; though I realize that it is much easier to obtain service and repairs in the city.

It is amusing to notice that a dealer who is an automobile mechanic, druggist or grocer immediately becomes a first-class radio-trician as soon as he secures the right to sell a certain make of receiver; and is thereby considered thoroughly capable of making any necessary repairs.

On the other hand, consider the man who has spent hundreds of dollars and all his time for years, studying often till midnight on radio work. The manufacturer will often refuse to sell him a single repair part, for fear that he is not capable of installing it. The dealer who has spent all his life specializing in some other trade is, of course, thoroughly capable. That is one of the worst propositions, in a small town, to secure necessary replacements. To me, it is far more important than to secure service data and diagrams. A good Service Man can get along without the latter though, we must admit, he can work to better advantage and save time with them. I have now about three hundred, and they come in handy lots of times; but the replacement parts are absolutely necessary, and it is best to use those designed for a given circuit.

I will recount only one incident: about six months ago, a customer brought in a magnetic speaker of a well-known make. Examination showed an open coil, and he left the speaker for repairs. I immediately wrote the nearest dealer (who was about 25 miles away) to send me a new unit C. O. D. After thirty days of patient waiting, my letter came back, with the address of the distributor in St. Louis and the advice to order from them, scrawled across the bottom. I wrote the distributor ordering the part C. O. D., and in about a week received a letter telling me to send them the speaker, and they would repair it and send it back.

All this time the customer was waiting for his favorite speaker; as he thought it the best he had ever heard.

I then wrote the distributor, telling him that there had been a misunderstanding somewhere; I simply wanted a new unit and would pay for it. If he would not furnish replacements for the product he had put on the market, I would appreciate a reply

to that effect, so that I could advise my customer.

As most Service Men can guess, the letter was never answered. I cannot say whether or not a similar situation exists in larger cities; but I can say that the speaker was repaired, despite the obstructive policy encountered. I immediately purchased and installed a unit of a different make; as I have found that other companies make them

This page is for the expression of opinions on the customs and conditions of the radio trade as they affect the Service Man. Service Men who have not already done so are invited to enroll in the National Radio Service Men's Association by filling out and sending in the blank on page 8. The "Opportunities" column of this month's issue of RADIO-CRAFT will be found on page 57 of this issue. The Service Man who desires to take advantage of this feature may do so without cost, as explained there.

and are glad to sell them. I selected one of high grade and well-suited to the output of the set. I told the customer to try it for ten days and, if satisfied, to pay me \$7.50; if not, to return it, and it would cost him nothing. Within twenty-four hours, to my surprise, he returned and gave me a check; and said that it was the first time he had heard a really good speaker.

On another occasion I wrote a manufacturer, asking if he would cooperate by furnishing diagrams, etc. In due time, a nice letter came, informing me that their sets are of such high-class material and workmanship that no servicing is necessary, other than replacement of tubes occasionally!

I believe that such troubles can be remedied by a little thought and cooperation, to the benefit of all concerned. It is a very expensive procedure for a set owner in a small town to crate up his set, pay shipping charges for two or three hundred miles, and wait a month or so to have a minor trouble corrected; when he could have it done at home with much less expense. The majority of the replies by manufacturers, in the May issue of RADIO-CRAFT, sound quite fair and reasonable, and offer all that anyone could expect; and I believe that a little more attention to the matters I have pointed out above would make it possible to remedy conditions to the satisfaction of everyone.

K. PERRY,
Thebes, Illinois.

SHEEP VS. GOATS

Editor, RADIO-CRAFT:

Every good Service Man knows how many screwdriver mechanics there are in the business. Can he really blame the manufacturer? It is true that diagrams would save a lot of time on some jobs; but if you are going

to be an independent Service Man, you can't get them; so why cry about it?

I have a great many customers whom I have taken from the dealer, because he couldn't service the set properly. Why not? He had diagrams and manuals, but he wouldn't pay a living wage, and therefore he gets screwdriver mechanics. Again I say, how is the manufacturer to know the sheep from the goats?

BLAINE MARTIN,
1933 East 73rd St., Cleveland, Ohio.

(Another expression of the sentiment which is now leading manufacturers to cooperate with Service Men in the founding of the National Radio Service Men's Association.—Editor.)

SERVICING BY SPECIALISTS FOR DEALERS

Editor, RADIO-CRAFT:

I have to agree with the radio manufacturers in all their points IF their respective dealers are capable of doing just what is necessary, and have the shops, the equipment and the men (and, if they have very good men, pay them very good money to do very good work). The average dealer does not know anything about the radio art; he figures on getting a cheap Service Man and, in nine out of ten cases, giving him a 2x4 space for a work bench and telling him to hurry up. Then, if he doesn't find out what the trouble is, the set goes back to the factory or wholesaler. And that hurts everybody concerned—the manufacturer, the dealer, the customer, and even the poor Service Man.

A lot of the manufacturers think when they invite dealers to send their Service Men to the factory for free instruction, that those men can go through a condensed training course in a week or so and then go home with a handful of service sheets knowing what it is all about. This can be done in some cases, for some men can grasp a new idea and understand it; but most of them let it go in one ear and out the other. The dealer is paying for their time, and they are enjoying themselves in new surroundings. I know some young fellows who went to the RCA school; when they returned, I was anxious to find what they had learned about the new models. After listening to their explanation, I didn't know much about the "RCA 60," and neither did they; but I know that they had all had a good time. This, of course, will not happen in all cases; but this is certain, that the average dealer expects too much from the average Service Man.

A good Service Man should have had at least three years' full time experience; should be equipped with a complete assortment of good tools and the very best test set obtainable. And, above all, he should not be a salesman; he should fix and repair only.

The trouble with some Service Men is that, once they are praised for some good work, they quit learning; for they then

(Continued on page 47)

SILVER RADIO MODELS 30 (CHASSIS), 60 LOWBOY, 95 HIGHBOY AND 75 CONCERT GRAND

This chassis utilizes '24 type screen-grid tubes in the first four stages: an aperiodic antenna coupler feeds V1, which is connected to V2 through the band selector L2-L3-L4. V3 is the third R.F. stage, and V4 a power detector which is followed, however, by a '27-type first audio stage V5. In the push-pull power stage, V6 and V7 are '45s.

The volume control in this receiver is the 10,000-ohm potentiometer P1; while the low-resistance instrument P2 is the hum balancer. P1 is a metal-frame component ("PP No. 4477"—Yaxley "Type 510,000") and must not, under any circumstances, be replaced with one of the earlier bakelite frame type. When inserting a new unit, drop a fiber washer over the shaft bushing; the lock-nut should be removed and a fiber spacing washer used to insulate the potentiometer shaft from the metal chassis. After replacing the front panel, which is fastened by the lock-nuts of the power switch SW1 and the "overtone switch" Sw2, a second fiber spacing washer is dropped over the shaft of P1, and its nut tightened. A test for a ground to the chassis should be made before soldering the connecting leads of P1.

While the low-note amplification of this receiver is high, and the normal operating hum faintly discernible, if this becomes excessive try other tubes in the detector and audio sockets. The power tubes should be selected for matched characteristics.

In the earlier models of this receiver, the cathode resistor R8 was connected to the white lead of the condenser hank C13, and thus bypassed by 1 mf. capacity; while both red leads of C12 ran to the cathode of V4. In these receivers, produced before July 8, 1929, it will be found desirable, for the reduction of hum, to rearrange the connections as shown in the diagram below.

The receivers with a serial number above 12,907 contain the "Type 30 filter"—comprising L12 and C14; in the 25-cycle models, C14 is connected as indicated in dotted lines; in 60-cycle receivers, as shown by full lines.

In receivers of a lower number, it may be desirable to add this unit to reduce hum. Without it, plate potential readings taken from these sets will be found about 10 volts higher than the figures shown below; in later models, the resistance of the choke coil L12 ("No. 339U") causes this drop.

The following figures represent the average readings obtained on a Jewell "Model 199" set analyzer, with the line-voltage at 114 and the volume control set at maximum:

Tube	Screen	"A"	"B"	"C"	K	Plate	Ma.
V1	60	2.25	142	1.0	1.0	2.6	
V2	58	2.25	140	1.4	1.4	2.3	
V3	58	2.25	140	1.2	1.2	3.2	
V4	40	2.25	55	5.4	10	0.2	
V5	—	2.30	176	—	12	6.5	
V6	—	2.30	205	40	—	28	
V7	—	2.30	205	40	—	28	

In normal operation, this receiver may be tested for noise by shorting the antenna and ground posts, and turning P1 to the full "on" position. Practically no background noise should then be heard at 550 kc.; no appreciable hiss becoming evident until the "Selector" drum has been turned to 1500 kc. Excessive noise may be due to tubes, wiring, or parts. Interchange the '24s until a quiet one has been obtained for V4, and another for V1 (the right-hand or first R.F. socket). V2 is the least critical '24 position.

Inability to receive stations between 200 and 214 meters (1400 and 1500 Kc.), or crystal-controlled transmissions below 230 meters (above 1300 Kc.), at their designated positions on the "Selector" drum, indicates the need for re-alignment of the tuning condensers. The correct procedure is: first, remove the chassis from the cabinet, and put it in operation with the shield-can cover resting over only the first three (R.F.) compartments. Next, tune in a weak signal between 240 and 230 meters (1250 and 1300 Kc.), and start with the aligning condenser in shunt with C4; then, in succession, align C3, C2, C1. To align C2 for loudest signal, it will be necessary to unsolder the red wire from the rear stator soldering lug of C1. Then re-solder the red wire to the stator lug of C1 and unsolder both wires (but leave them connected to each other) from the stator lug of C2; and align C1 for loudest signal. Re-solder the wires to stator lug of C2. When they are properly adjusted, the aligning screw of C4 will be practically all the way in; those of C3 and C2 nearly all in; while that of C1 will be nearly all out and with frame and spring separated about 1/8-in. It is absolutely essential that the drum dial and volume control settings remain unchanged during the above operations, which must be carried out in the order specified. If the receiver will not tune down to 200 meters (1500 Kc.), the aligning process has been carried out with the aligning condensers screwed too tight.

If the loud-speaker frame becomes ungrounded

and "floats," the receiver will usually oscillate; as, also, if the ground lead is unconnected, poor tubes are in use, the R.F. plate leads incorrectly located, or tube shields not firmly in position. It is vitally important that the three red R.F. plate leads (leading from lugs of sockets of V1, V2, V3, through and under chassis partition to their respective inductors) be pushed down carefully into the angle between the chassis and the partitions, where they run from the socket lug up to the slot in the partition. If, during previous servicing, these leads have been allowed to straggle through the set, and are not placed exactly as specified, the circuits will invariably oscillate. An infrequent cause of circuit oscillation is a short of L10; or a defective C5 or C8.

If the "overtone" switch SW1 fails to change the timbre of programs, carefully check the values of C5, C7 and C8.

A tension screw on the hub of the dial, which is held by a lock-nut, permits the drive cord to be tightened when necessary.

If it becomes necessary to replace an R.F. coil, the replacement coil must have upon its end the same crayon identifying number as the defective coil.

The following values are used in the Silver "Model 30" chassis: C5, C7, .00015-mf.; C6, .006-mf.; C8, .001-mf.; C9, C10, C11, C12, 0.1-mf.; P1, 10,000 ohms; R1, R2, R3, 400 ohms; R4, R5, R6, 2600 ohms; R7, 60,000 ohms (blue); R8, 2,000 ohms (white); R9, 10,000 ohms (green); R10, 300,000 ohms (yellow); R11, 3500 ohms (brown); R12, R13, one 800-1500-ohm tapped resistor; R14, 2 meg. (red); C14, 2 mf. L1, L7, L8, L9, L10 are "Type 274U" R.F. chokes.

A screen antenna is contained inside the cabinet top.

To readjust the gang condenser bearings, if they are too tight, loosen the dial set screws sufficiently to free the dial, after removing the chassis. Adjust the condenser so that the rotor turns freely. First release all rotor spring tension screws. If the condenser is still tight, or if end-play exists, the thrust screw must be carefully adjusted. The rotor spring bearings should be adjusted one by one, so they do not press the rotor shaft upward. Otherwise, the screw should be completely removed and the upper spring so bent as to bear down upon the rotor shaft (as the screw is tightened) before the lower rotor spring forces the shaft upward. The proper adjustment of the rotor springs is when they are not loose enough to cause vertical play, but permit side play.

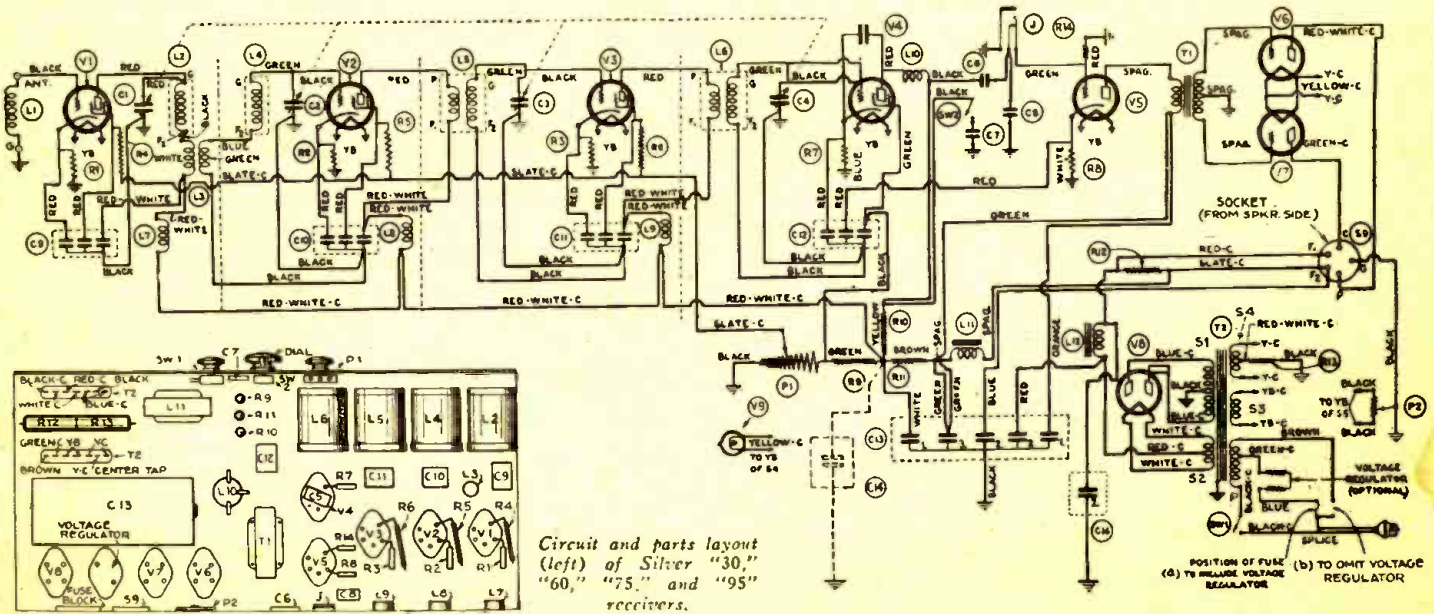

Circuit and parts layout (left) of Silver "30," "60," "75," and "95" receivers.

POSITION OF FUSE (a) TO RAISE VOLTAGE REGULATOR (b) TO OMIT VOLTAGE REGULATOR

EVEREADY SERIES 30, SERIES 30-C AND SERIES 40 RECEIVERS

Changes in the audio chassis and reproducer are the only things that distinguish the "Series 40" circuit from the "Series 30;" the former uses type '45 tubes in push-pull, the latter type '71A. To supply the power for the '45s, (S4 wound to deliver 2.5 volts and S1, 250 volts) the No. 2708 unit must replace No. 2460 (PT); a higher-voltage-rating condenser bank, No. 2707, replaces No. 2295 (C19); correct "C" bias is obtained across a 900-ohm resistor No. 2705, instead of No. 2339 (R8); tube sockets No. 2704 (designating '45 tubes) replace sockets No. 2252 for V6 and V7; the output transformer No. 2463 (T3) used in "Series 30-C" and "Series 40" receivers for Eveready dynamic reproducers has a ratio of 25-to-1; while this dynamic unit has a field resistance of 5,000 ohms. "Model 30" (table model) has a No. 2293 A.F. transformer unit, T3, with a ratio of 1-to-1. Jensen D-5 or Newcombe-Hawley NH.7 reproducers may be used with the No. 2463 transformer in the "30-C"; the field current available from the receiver is 4 watts at approximately 110 volts D.C.

An unusual feature of the design of these receivers is the use of a variometer, L1, which is ganged to the variable condensers C2, C3, C4.

The tubes used in the "30," "30-C," and "40," are as follows: V1, V2, V3, V4, V5, type '27; V6, V7, type '71A or type '45, as explained above; V8, type '80; V9 is a 2.5-volt pilot light.

Additional data on the remaining units is given below: Condenser C1, in shunt with L1, is operated from the panel and serves as an antenna trimming unit; C2, C3, C4 have a common shaft and, if the rotor plates loosen, it is necessary to remove the R.F. shield, drive cable, and variometer, and then replace the three-gang condenser with another No. 2192 assembly; C5, C6, C7, in shunt with C2, C3, C4, are aligning units, each mounted on one end of the respective tuning unit; C8 has a capacity of .00025-mf.; C9, .0001-mf. C10, C11, C12 are neutralizing condensers, mounted on a hard rubber strip in the R.F. sub-panel and reached through three holes in the rear of the chassis; C13, C14 are 0.5-mf.; C15 is 2 mf.; C16, 1 mf.; C17, C18, 1 mf.; C19, 2 mf., and C20, 4 mf., constitute filter bank No. 2295, and the capacities are tapped in this order; C20 being nearest to the mounting base of the bank; The can is the common, grounded side. C21 has a capacity of .0002-mf.

Grid leak R1 (red stripe) has a resistance of 2 meg.; hum-balancing potentiometer R2 is 10 ohms; R3, 1,750 ohms; R4 (green stripe) 17,500 ohms; R5, 3,500 ohms; R6, volume-control potentiometer, 600 ohms; R7, 175 ohms; R8, 1,000 ohms; R9 is the usual center-tapped resistor (which may be 15 or 20 ohms). R10, of 2,500 ohms, takes the place of the reproducer's

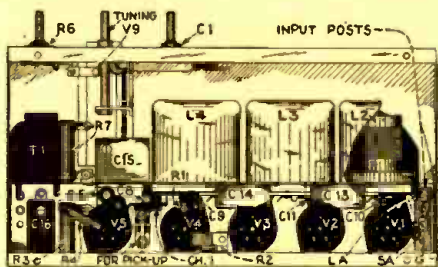

Under view of the receiver chassis of the Eveready "30," "30-C," and "40" receivers; the variometer, mounted on the top of the chassis, is on the same shaft with the tuning condensers.

field coil in models in which the dynamic speaker is not used.)

Voltage compensation in PT is obtained by putting the "plug" into the hole marked with the line-voltage figure which is nearest to the measured value of the power supply.

To facilitate shop service, Service Part No. 2715, an extension cable with terminals to fit over the connector strips on the R.F. and A.F. chassis, is available for the purpose of making external substitution of an R.F. or A.F. chassis; which enables checking by the substitution method, without removing either cabinet chassis.

Volume control R6 varies the positive potential of the cathodes of V1, V2, V3, in relation to ground; inversely, this varies the negative bias on the grids of these tubes, the grid returns of which are grounded. Defects in this part of the circuit may occur as a short of the movable arm of R6 to ground (chassis); broken wire in winding of R6; short leads to R6.

If, for any reason, the braided-copper drive cable around the tuning drum becomes too loose to grip the drum dial properly, a new cable (unit No. 2257) or spring should be installed.

It is recommended that, to neutralize the set, a dummy tube be used in conjunction with an oscillator and an indicating meter; and adjustment be made for zero indication, starting with C12 (V3).

To align the circuits, the same oscillator and meter are recommended; adjustment being made of C5, C6, C7 (in this order). Align for maximum meter reading of A.F. output. To adjust the variometer, tune the receiver and oscillator to resonance at about 40 on the dial; loosen the two screws holding the variometer bracket to the gang condenser cradle, and rock variometer for maximum signal;

tighten the two screws. Repeat this procedure at 75 and 25 on the dial. If the tuning circuits do not tune as sharply as normal, or signal strength is not at par, make certain before aligning that the condenser plates are not out of position.

For aligning and neutralizing, an insulated wrench is required.

The R.F. inductances are matched in one group. The voltage drop across the portion in the secondaries is the neutralizing potential.

Hum often may be eliminated by changing detector tubes, readjusting R2 for each tube.

The voltages normally found in these Eveready receivers are as given below:

Tube	"A"	"B"	"A"	"B"	"C"	"K"	Ma.1	Ma.2
V1	2.5	109	2.45	100	6.0	6.0	2.5	6.0
V2	2.5	109	2.45	100	6.0	6.0	2.5	6.0
V3	2.5	109	2.45	100	6.0	6.0	2.5	6.0
V4	2.5	109	2.45	50	0.0	0.0	3.0	3.2
V5	2.5	109	2.45	100	4.5	4.5	3.0	4.3
V6	5.2	192	5.10	175	37.5	—	20.0	24.0
V7	5.2	192	5.10	175	38.0	—	20.0	24.0
V8	—	—	5.10	—	—	—	44.0	—

These tests were made with a line voltage of 119, "plug" in the 115-volt tap, and the volume control turned full on. The second and third columns, "A" and "B," are readings with the tube not yet placed in tester; Ma.1 indicates normal plate current and Ma.2, plate current upon grid test.

The circuit shown in the diagram is an "R.F.L." (Radio Frequency Laboratories) hookup; all Eveready receivers in the "30" series are identical as respects the chassis.

The response characteristic of a circuit tuned by a variometer is exactly the reverse of one tuned by a condenser; that is, the circuit becomes more sensitive as it is tuned to the higher wavelengths. The two methods are combined in the design of this receiver to obtain even amplification throughout the tuning range.

Volume control R6 is a wire-wound unit.

Directly below the field terminal jacks on the Table Model is a snap switch (SW3) which is thrown one way for dynamic, and the other for magnetic, speaker operation. The field coil of the reproducer plugs into pin jacks located on the rear face of the power plant; and the voice coil into two pin jacks mounted between the power tubes.

The insulated terminal board, for adjustment to compensate line-voltage conditions, is mounted on top of the power plant between the power tubes and the rectifier; the removable plug is to be inserted in one of the three holes in the top of this board.

The "Model 30" chassis is designed for easy servicing by separate removal of either the set chassis or the power chassis. When the two units are reconnected, care should be taken to see that the busses are tightly bolted.

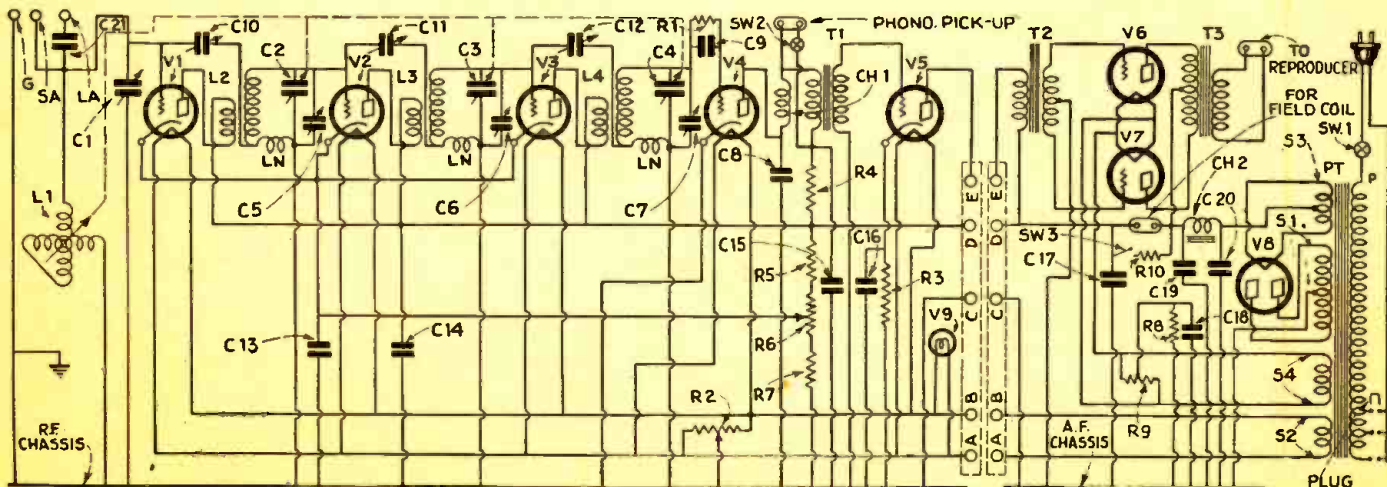

Fidelity or Volume in Reproduction?

A study of distortion, with special reference to A.F. transformers

By SYLVAN HARRIS

THE question which forms the subject of this article has been very much neglected, yet it is of considerable importance. It is a commonly-known fact that, in nearly all receivers, the quality of reproduction changes as the volume control is varied. Sometimes this change is very marked; at other times it is hardly noticeable. Nevertheless, the change is always there, and it can always be detected; although, unfortunately, it cannot always be corrected.

In discussing any subject we must have a condition of reference; that is, one to which we make a comparison at any point in our discussion. For example, we may consider as a reference condition for this discussion what we term *ideal* fidelity; which means that sounds of all frequencies would come from the loud speaker with amplitudes of exactly the same relative ratios as those of the various sideband components which enter the receiver via the antenna.

Note that we do not consider what is going on during transmission from the sending station to the receiver. There is a certain amount of frequency discrimination in the ether; due to the fact that the attenuation is a function of the frequency, and that, for the present, it is beyond our control. Then, too, there is initially a certain amount of distortion, however little, between the microphone and the antenna, at the transmitting station; but this is a matter for the transmitting engineers to consider, and is not a problem of the receiver.

For these reasons the fidelity characteristic of a radio receiver should be considered between the antenna and the ear. Let us now classify the various kinds of distortion which are created in the receiver. Some of these items will not be new to the reader; there are several, however, which are not generally taken into account, and with which this article will be mainly concerned.

Causes of Distortion

- (A) R.F. Amplifier:
 - (1) Sideband cutting
 - (2) Cross-modulation

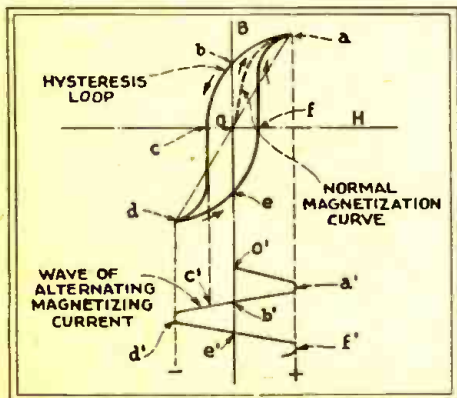

Fig. 2

Since iron has a quality opposing change in the value of its magnetism, the magnetic flux in an iron core does not follow exactly the changes in the current causing it.



MR. HARRIS in this article, the fifth of a series dealing with the problems of radio engineering in receiver design, and the methods employed for their solution, throws some light on the much-discussed "perfect audio reproduction."

- (a) Heterodyning in first stage; due to beating together of two stations, and tuning of the following circuits to the beat frequency.
- (b) Mixing of two signals at the grid of the first tube; the circuits being tuned to one signal and the other, a very strong signal, being forced upon the grid because of insufficient pre-selection. Rectification occurs; due to either plate-characteristic curvature, or the flow of grid current.

- (B) Detector:
 - (1) Grid-leak and Condenser circuit—
 - (a) Audio-frequency attenuation by grid-condenser and grid-leak combination.
 - (b) Distortion, due to curvature of grid characteristic.
 - (c) Distortion, due to curvature of plate characteristic.
 - (2) "C" bias Detector—
 - (a) Distortion, due to curvature of grid characteristic (Overloading).
 - (b) Distortion, due to curvature of plate characteristic.
- (C) Audio Amplifier:
 - (1) Tubes—
 - (a) Distortion, due to curvature of grid characteristic (Overload)
 - (b) Distortion, due to curvature of plate characteristic.

- (2) Transformers—
 - (a) Distortion, due to curvature of magnetization curve.
 - (b) Variation of the inductance of transformers with the strength of signal current.
 - (c) Variation of the inductance with the value of the direct current flow.

The causes of distortion in the R.F. amplifier are fairly well known. Sideband cutting is an everyday topic of conversation in radio circles; and the matter of cross-modulation has been discussed by the writer in a previous article in the May issue of *RADIO-CRAFT*.

Causes of distortion in the detector are also fairly well known. Decreasing the grid-leak resistance or increasing the grid-condenser capacity results in improved reproduction of the lower audio frequencies. The grid-leak detector acts by virtue of the current which flows between the grid and cathode, and this causes distortion for two reasons.

First, the resistance between the grid and cathode is much less during the positive half of the cycle of signal voltage than during the negative half. Therefore, the signal voltage on the grid is less during the positive half than it is during the negative half of the cycle. This produces *amplitude* distortion.

Curvature of the plate characteristic of

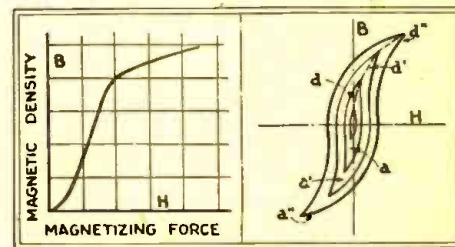

Fig. 1

Fig. 3

The magnetism of a core alters less and less, as the exciting direct current approaches saturating value. This effect, in the alternating-current "loop," is translated into the curve of Fig. 4.

the detector causes distortion in the same way that curvature of the characteristics of amplifier tubes causes distortion; that is, by introducing undesired harmonics into the signal. This cause of distortion is equally present in both types of detectors; although it is more serious in the "C" bias detector, because of the necessity of operating at the bend of the plate-current curve.

Distortion due to overloading may occur of course, in any tube of the receiver; and it may be avoided by correct design, or by correctly operating the receiver.

Actions in A.F. Transformers

We now come to the matter with which this article is most concerned; that is, the distortion which is due to variations in the characteristics of audio transformers.

An audio transformer consists of two windings upon an iron core; its inductance

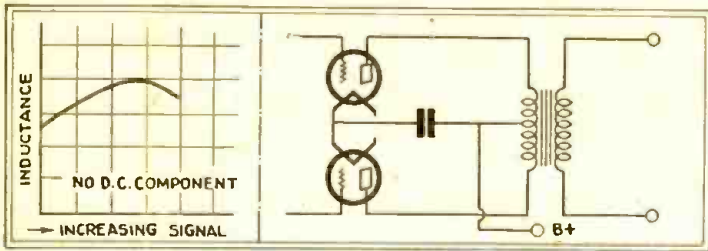

Fig. 4 (left)
The inductance of a transformer rises with the signal to a certain point and then falls off as saturation is approached.

Fig. 5 (right)
A push-pull circuit balances out the D.C. magnetization of the core by plate current.

Effect of Saturation

As the magnetizing current is increased the hysteresis loop becomes larger and larger, the tips of the loops always falling upon the normal magnetization curve. At first the slope of the line joining the tips increases as the current increases, and so the permeability and inductance increase; but after a while the slope begins to decrease. This is indicated by the slopes of the lines *ad*, *a'd'*, *a''d''*, in Fig. 3. And so, considering a transformer which has flowing in it only an alternating current and no direct-current component, the permeability and consequently the inductance, increases as the current increases; and later, as saturation is approached, the inductance begins to decrease. This effect is illustrated in the curve of Fig. 4, and shows what is to be expected in the output transformer of a push-pull amplifier stage such as that of Fig. 5. The direct currents flowing in the two halves of the primary winding annul each other, so far as magnetizing effects are concerned, and the transformer acts as if there were no direct current flowing in it. The inductance increases as the signal increases. Care is always taken in the design, to avoid operation at or near the condition of magnetic saturation. The top curve of Fig. 6 shows actual measurements made on a transformer in which there was flowing no direct current, but only an alternating signal current. As the signal current increases, the inductance increases steadily.

So, in the case of the push-pull stage, the transformer impedance changes with the signal strength and this of course, influences the fidelity of reproduction. The stronger the signal voltage, the greater the inductance, and the greater will be the amplification of the lower audio frequencies.

The conditions are quite different when we have a direct or constant current flowing through the winding, in addition to the alternating signal current. Suppose we start with a completely demagnetized core, and simply turn on the switch of the radio set, without tuning to a signal. Referring to Fig. 7A, the magnetization builds up to the point *a*. Now let us turn off the current.

(Continued on page 44)

depends upon the change in the magnetic flux which a given change of current in the coil will produce. For example, Fig. 1 shows the form of the normal magnetization curve of iron. The magnetizing force *H* is plotted horizontally, and is a function of the number of turns in the magnetizing coil (in this case, the primary winding) and the amount of direct current passing through it. In other words, the magnetizing force *H* is proportional to the ampere-turns.

The magnetic flux established in the iron core, by this magnetizing force, is represented on the vertical axis, where *B* is the magnetic density; that is, *B* is the magnetic density, or the number of lines of magnetic flux passing through each square centimeter of cross-section of the core.

As the magnetizing force is slowly increased the magnetic density increases as shown by the curve; until, after a while, a condition is reached in which further increases of magnetizing force produce only small increases of flux density. This is the condition of *saturation*; which is always to be avoided, and generally is avoided in practise.

Now let us see what happens when we start with the iron completely demagnetized, and pass through the coil a pure alternating current; that is, with no direct current flowing in the winding. Suppose the current starts at zero and begins to increase on the positive half of its cycle, as shown at *o'* in the lowest curve of Fig. 2. As the current increases, from *o'* to *a'*, the magnetic density increases along the normal magnetization curve *oa*, shown by the broken curve. Next, the current decreases from *a'* to *b'*, and the density decreases along the curve *ab*. At *b'* the current is zero; yet we see at *b* that there is a certain amount of magnetization

in the core, represented by the distance *ob* above. This is called the *retentivity* of the iron, and indicates the ability of the iron to retain its magnetization. Then, as the current goes through the rest of the cycle, as shown in the lowest curve, the magnetization goes through its cycle as shown above. A closed curve is formed; which is known as the *hysteresis loop*, and which is caused by the *retentivity* of the iron, or the capability it has of retaining a certain amount of the magnetism. As the current goes through one cycle after another, the loop is repeated over and over again.

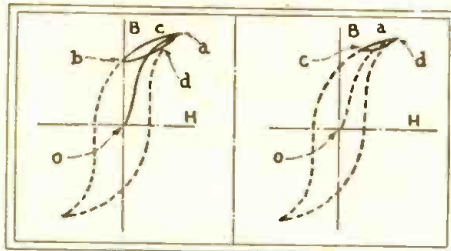

Fig. 7A

Fig. 7B

The retention of magnetism by a core lessens the effect of an alternating component in transformer windings, and consequently the effective inductance.

Now, as we have said before, the inductance of the primary of a transformer is measured by the change of magnetization which a given change of magnetizing force will produce. This is the same thing as saying that the inductance of the coil is proportional to the slope of the line drawn from the origin *o* through the tips of the hysteresis loop, or the straight line *ad*. The *slope* of this line is called the *permeability*; and is proportional to the inductance of the coil.

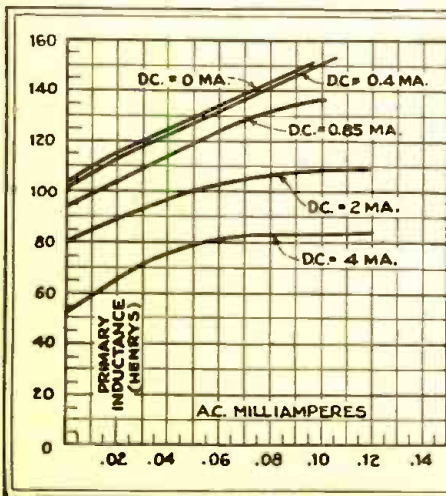

Fig. 6

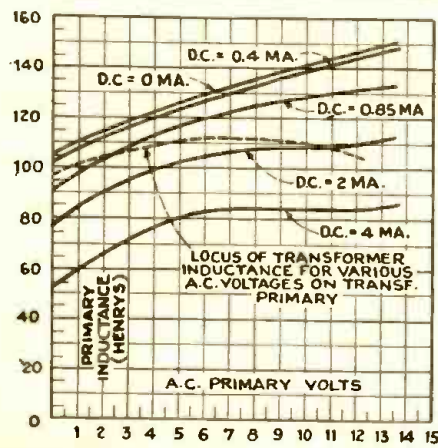

Fig. 8

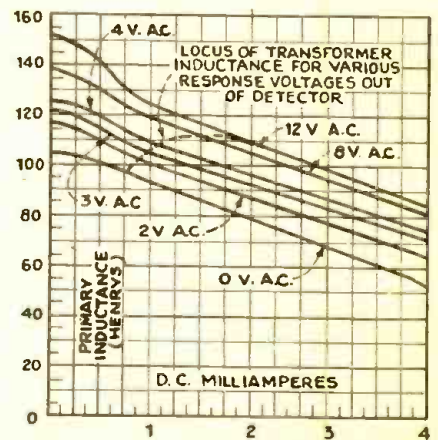

Fig. 9

At the left, we see how the inductance of a transformer increases with the alternating signal; but it is higher as the direct-current component is lower. At the right, we see how distinctly the flow of direct current reduces the inductance. The graph in the center makes evident that the inductance is increased by the stronger signals; thereby improving low-note reproduction.

The Latest Developments in Television Methods

By LAURENCE M. COCKADAY

SINCE the days of Greek mythology, when the common mirror came into being, there has been something fascinating about an image or reflection. This fascination led to the invention of the camera in 1558 A.D., and finally to the perfection of the motion-picture camera in the early part of the twentieth century. All of these discoveries and inventions are the forerunners of a new means of reflecting images, which is virtually upon us. This new science is *television*; the transmission of visible images by wire and radio.

Television is now a successful laboratory device. The past year has seen many outstanding improvements and practical laboratory perfection of the transmission of moving images by both wire and radio circuits. With some hesitancy (because some experts will disagree, who are strongly opposed to the inception of television) I venture to predict that, within the next two or three years, home television will assume the same status with the public that broadcasting did when it first gained a foothold in 1922.

Television Service Men Soon

Obviously, there is bound to be a demand for experienced technicians to service commercial television receivers the instant the public becomes sold on television. This will create an entirely new branch of radio servicing. Fundamentally, television involves basic radio principles, employing to

a large extent identically the same apparatus, such as tubes, resistances, batteries, etc. Logically enough, those who will be qualified to service television are the radio experts who have already basic experience in radio and who, with past technical training, may apply it to the new science.

The enterprising municipality of Jersey City, N. J., inaugurated early in April the first television "theater" in the United States. Less than a week after this event, the Bell Laboratories announced demonstrable two-way television.

These two developments, while not marking an entire departure from the laboratory stages, will have the effect of accelerating the practical application of this new art.

Perhaps the greatest number of technical contributions are to be found in the apparatus for two-way television demonstrated by the Bell Laboratories. Two duplicate sets of apparatus were set up for this experiment—one in the Bell Laboratories building at 55 Bethune Street, New York



Fig. A

The two-way television with its screen removed to show the microphone (above) and loud speaker (below).

City, and the other, about two miles away at 195 Broadway. While transmission was effected by wire, the same fundamental principles are involved as those of radio television.

Two-Way Television

Apparatus at each end of the circuit was housed in a sound-proof room slightly larger than a standard telephone booth. This writer was among the first to have the privilege of entering the "television booth" and to converse with a friend at the other end of the circuit. The effect of seeing the other "party" and at the same time knowing he was several miles away, was decidedly uncanny.

Upon my entering the room which contained the television booth, an operator gave full instructions. She told the name of the party who would be at the other end. In the booth was a chair. In a small aperture was a sign reading: "Ikonophone. Watch this space for television image." Presently the sign was removed by an operator behind the booth, and the image of the person to whom I spoke appeared. Talking was simplified by the use of a concealed microphone which recorded the voice, and a loud speaker which brought the synchronized words of the speaker "on the other end." It appeared almost as if the animated pink-and-orange image in the aperture were actually talking.

The use of pure blue light for scanning, rather than the bright white illumination which has been employed in past experiments, contributed largely to the success of the affair. Had the bright light been used, it would have been impossible to see the neon-colored received image. Blue light is soft to the eyes, but reacts on the sensitive element of the special photoelectric

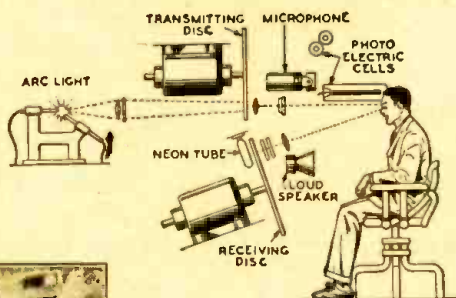
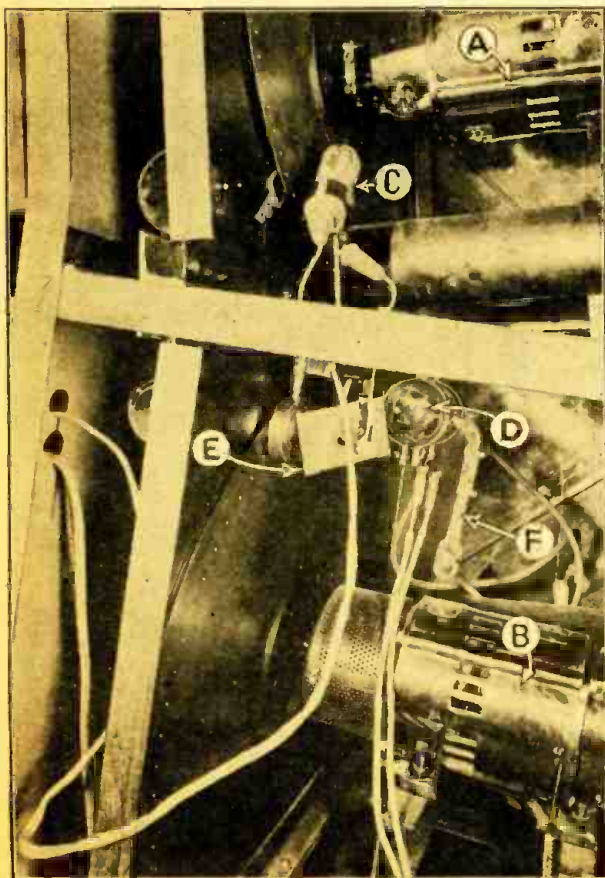

Fig. 1

Above, a diagram showing the arrangement of the acoustical and visual equipment used in the two-way television and -phone system. The photoelectric cells are banked around the subject scanned, as in the illustrations of Dr. Ives' article in January RADIO-CRAFT. A 40-kilocycle band is required for the 74-line image transmissions.

Fig. B

At the left, a view behind the scenes of the "Ikonophone"; the works of the television pick-up (upper) and reproducer (lower) scanning discs. At A, the housing of the motor which drives the scanning disc of the transmitter; this causes a spot of concentrated light from the arc lamp at the back of the cabinet to sweep the features of the subject before the apparatus. The neon lamp C is a "monitor," to enable the operator to see the outgoing image, as it is picked up by the photoelectric cells, after being scanned by the light pencil passed by another part of the disc; note the mask at lower portion of upper disc, and the lenses at left of C and E. By the aid of the mirror E, the incoming image also is made visible (monitored) at the side. B is the driving motor of the scanning disc of the receiver. Observe the tubes leading from the water-cooled neon tube D, and its hydrogen valve F. (Photos and diagram courtesy Bell Telephone Laboratories.)



* From the Greek words "Eikon," an image and "Phonon," to speak. Hence, "the speaking image."

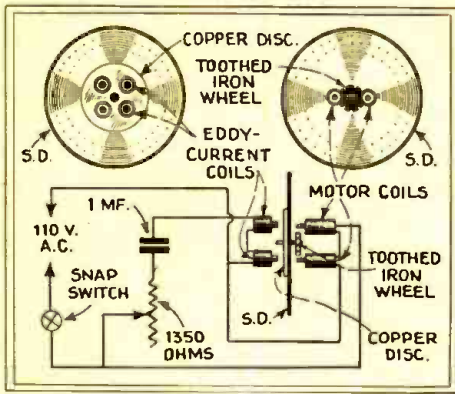

Fig. 2

The ingenious driving and synchronizing system of the latest Jenkins radiovisor.

cells equally as well as white lights (See page 577 of *RADIO-CRAFT* for May). This blue light is obtained by employing a filter in front of the arc scanning light.

A new type of water-cooled neon tube was used for reproducing the received image. The new tube has a hydrogen valve, and is much faster in action than previous types used, giving a much clearer image on the receiving end. This lamp reproduces the image satisfactorily when the effective value of the alternating current is of the order of 100 milliamperes. In order to operate such neon lamps at such low levels, it is necessary to shield them against electrical, mechanical and acoustical interference.

More Detailed Images

The reason for the excellent image in the two-way experiment is traced to the use of a seventy-four hole scanning disc, which gives almost double the number of scanning lines. (Forty-eight holes is the number most commonly used.) When reproduced in the aperture of a receiver, the 74-line image is comparable to the reproduction of a halftone cut in a newspaper.

There are two general systems of actuating photoelectric cells. (See Fig. A, page

317, January, 1930, issue of *RADIO-CRAFT*.) One is to use a single cell operating behind the scanning disc, and flooding the subject with powerful lights. The other is to scan the subject with a light beam in a darkened room, and to use three or four banks of photoelectric cells in appropriate locations to record the reflected light.

For outdoor television transmission, obviously, it would be impossible to use the bank system applied so successfully in the "booth" set-up. To scan the image with natural light, it is also necessary that extremely sensitive photoelectric cells be used.

a heavier central copper disc and a small, toothed iron wheel. "Eddy currents" are created in the copper disc by the four "eddy current coils." This construction serves four purposes: a starting torque is available to move the toothed iron wheel out of dead center relation to the motor coils; a field current is produced, which strengthens the field current of the motor coils; an electrical load, controlled by the 1350-ohm resistor, which tends to maintain even speed, is given to the spinning disc and, by varying the resistance and snapping the switch, proper speed and framing are obtained. The motor action is that usually found in induction motors; the teeth of the iron wheel being attracted by the motor coils when the current through the coils reaches a maximum value.

The Gould System

That the square-plate neon tube has certain limitations is recognized in engineering circles. A departure from this design of tube is seen in the work of a Bridgeport, Conn. experimenter, Leslie Gould, who has been working with spiral neon tubes, and has obtained some interesting results. He is also studying color television, by using different-colored neon tubes to obtain different degrees of tone.

In his television receiver he makes use of a revolving neon tube and a drum, which replace the usual circular disc and stationary square-plate neon tube. The Gould neon tube is in the shape of a helix and has two complete turns; resembling the tubular type now employed in advertising signs. This tube is surrounded by a circular drum perforated with holes which correspond to those in the usual disc. Both the neon tube and the drum are fastened to the hub of a motor, which revolves in synchronism with the transmitting disc.

Gould employs a small power oscillator to excite the neon tube. His method of obtaining variations in the light, in order to reproduce an image, consists of modulating

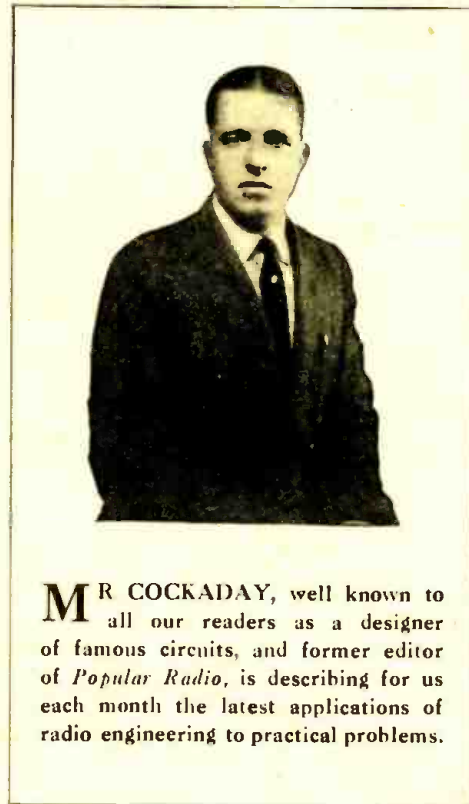

MR COCKADAY, well known to all our readers as a designer of famous circuits, and former editor of *Popular Radio*, is describing for us each month the latest applications of radio engineering to practical problems.

These cells have been perfected so that the light reflected, through the tiny holes of the scanning disc, into the sensitive element, gives rise to an alternating current whose value is of the order of one ten-thousand-billionth of an ampere.

The Jersey City television "theater" already referred to utilizes Dr. C. Francis Jenkins' system. In transmission, the so-called "camera eye" system, with a single photoelectric cell behind the scanning disc, is employed; while a total light of 4,000 candlepower is flooded on the subject. Simultaneous sound transmission is accomplished through station WRNY, which, incidentally, was first used in 1928 by the editor of this magazine, Mr. Hugo Gernsback, for the earliest New York television broadcasts.

These Jenkins receiving units employ a standard neon glow-lamp, connected directly with the "picture-frequency" output of the radio television receiver. The disc has forty-eight holes, and is driven by a synchronous motor, as described previously in *RADIO-CRAFT*.

A point of particular interest in the Jenkins television receiver, as so far developed for home use, is the motor unit, shown in schematic form in these columns (Fig. 2). The scanning disc, of thin aluminum, carries

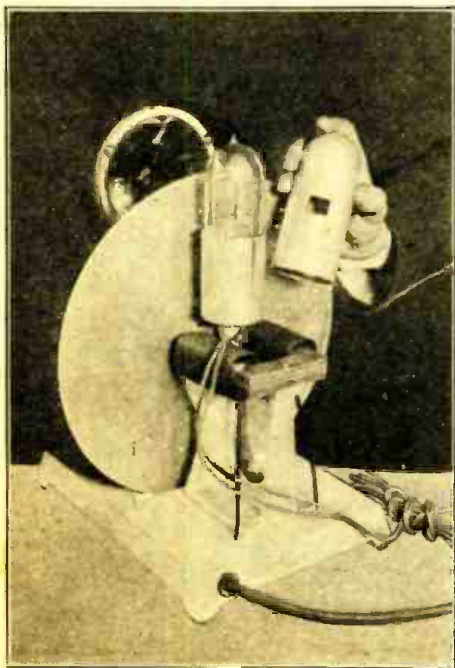

Fig. C

The neon tube, with its shield mask, adjustable to either 48-hole spiral of the 12-inch disc. The two "motor coils" are shown.

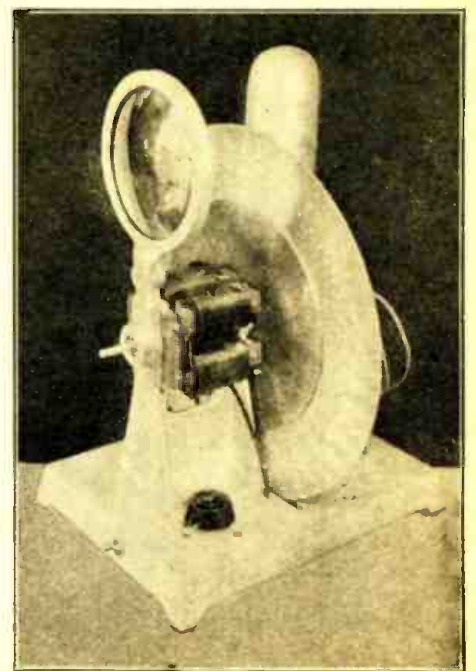

Fig. D

The commercial radiovisor from the front, showing the "eddy-current coils" and lens magnifying the reproduced image.

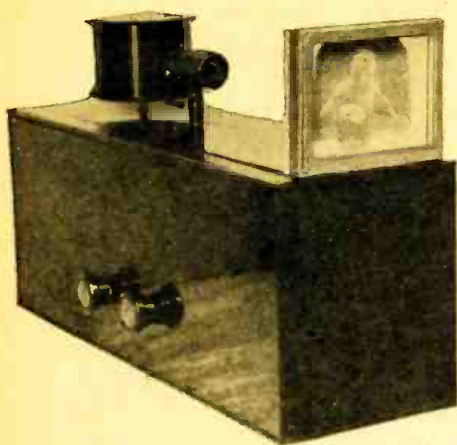

Fig. E (above)

One of the models of the Gould spiral-tube television receiver. The tube is housed within the vertical drum projecting above the cabinet.

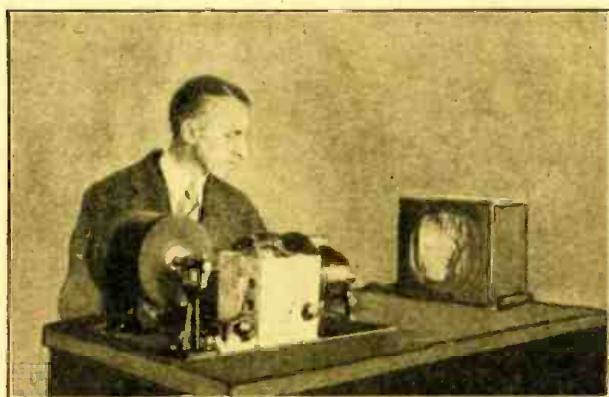

Fig. F (right)

Leslie Gould reproducing a television image in colors on the screen at the right, with one of his latest experimental models. The successive red and green impulses are reflected by an optical system through the scanner in the center.

the oscillator with a 7½-watt vacuum tube through a Heising circuit.

This causes a variation in the oscillatory impulses, which in turn increases and decreases the brilliancy of the neon tube. As the signals are received, the speed of the revolving drum is synchronized with that of the transmitting disc; so that the holes correspond to the parts of the image which are being transmitted. The light is projected through a camera lens, which enlarges the images and reflects them on a ground-glass screen about five inches square.

One of the unusual features of this receiver is the spiral neon lamp. Each of the

two turns of this lamp operates *separately*; that is, when the drum makes one revolution it automatically, by means of a commutator, disconnects the other portion.

Engineers are now developing gas tubes for Gould which contain a white glowing gas, and will permit reproduction of images like photographs in actual black and white, instead of the usual orange and black of the neon tubes.

Color Television

Gould's television receiver for reception of images in color is fundamentally the same as the regular television receiver, from which it differs in that special gas tubes are employed instead of the usual orange-colored lamps.

These are mounted on a six-inch drum,

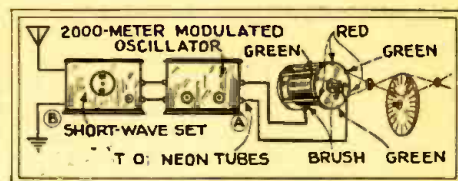

Fig. 3

Schematic arrangement of the Gould system of colored television reproduction.

ness of reproduction to place them rather farther along than aural radio broadcasting was in 1922. The time is fast drawing near when receiving sets for television will be in vogue, if the recent improvement in results is to be taken into account; and Service Men will do well to follow the developments with a more alert eye, in keeping up with improvements and new methods of transmission and reception of moving pictures at a distance.

The Service Man who is interested in undertaking the study of television must have a thorough knowledge of the principles of reception. In addition to radio, he must gain a knowledge of synchronous motors, neon tubes, photoelectric cells and how they are connected in the circuit. He must know how to adjust the machine to synchronization, in order to keep the image in the aperture, without "drifting." Such things are gleaned only from careful study of developments and advances in the art.

which revolves in synchronism with the disc. Three red and three green neon tubes are mounted on the drum, and are excited from an oscillator, which in turn is modulated from the received signal. As the drum and disc revolve, the colors are blended together; giving the effect of reproducing the image in true color tones.

The results obtained with any of the foregoing described systems of television are such that anyone would be glad to have a permanent installation for his amusement. Although these are laboratory set-ups, they are far enough developed to be used for home demonstrations, with satisfactory clear-

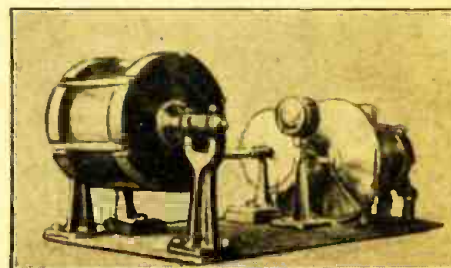

Fig. G

A close-up of the neon-tube drum and scanner of Fig. F (and Fig. 3); red and green tubes alternate on the drum.

Men Who Have Made Radio—Gen. G. A. Ferrié

THE TENTH OF A SERIES

SOLDIER and scientist, in the mind of the average reader, may well be two distinct personalities; yet, as the technical requirements of the military and naval professions become increasingly exacting, we find officers of both services assuming more and more prominence in those sciences which add to the victories of peace even more than to those of war. In exploration, astronomy, meteorology, medicine, engineering, they have played leading roles, and in radio as well. Outstanding, among this great array, is the internationally-famous Frenchman pictured here.

Gustave Auguste Ferrié, born Nov. 19, 1868 at St. Michel de Maurienne, Savoy (Southern France), graduated in 1887 from the Ecole Polytechnique; and two years later, as a sub-lieutenant of engineers, was assigned to the telegraphic service of the French army. In 1898 the development of "wireless" caused him to undertake an intensive study of this subject, which was to become his life work. In February of the



following year he was present at Marconi's demonstrations of radio communication between England and France.

In 1899 the recurring "Moroccan crisis" definitely fixed the career of Ferrié. He was designated chief of the radio section of the French signal corps; an organization then of dimensions not inappropriate to his grade of lieutenant. He has developed it until it is worthy of a general and, a few days ago, the Chamber of Deputies and the Senate of France voted that he should be exempt from the age limit governing the service of officers; in order that he may continue to direct the army's radio activities.

In 1899, also, appeared the first edition of "La Telegraphie sans Fil," a popular work of which he was co-author, explaining simply and lucidly the new "wireless" art, which has run through many editions. The book awards credit for the conception of radio to Tesla.

The initiation of French military radio, in practice, dates to 1900; and Ferrié was called upon then, and many times subsequently, by the French navy as well, for technical

(Continued on page 51)

The Amateur's Television Projector

With this equipment and 35-mm. silhouette film, any experimenter may work with wired television very conveniently.

By **ALEXANDER GORDON HELLER**

Chief Engineer, Insuline Corporation of America

TO date the amateur of television has, usually, been limited to receiving images sent out by some experimental transmitter. His efforts have often been interfered with by his distance from the transmitter and poor reception conditions; poor quality of the picture transmissions; infrequent and sometimes inconvenient times of picture broadcasting; and too often synchronization difficulties, due to the fact that the broadcaster was not on the same power line as himself, thus preventing the simple expedient of using synchronous motors.

Because his experiments and attempts at improvement of picture transmission and reception have involved so many factors beyond his control, his field of activity has been limited to improving radio reception and devising amplifiers and special complicated synchronizing equipment in connection with television.

To overcome this situation, the writer recently designed for the market a simple transmitter which, while no new principles of operation are involved, permits amateurs to investigate television (between two points connected by wire) as transmitted by a simple adaptation of a motion-picture projector incorporating standard 35-mm. safety film, and at a low initial cost and upkeep. Fig. A is a view taken from one side of the

transmitter; Fig. B shows its mechanism on the other side; while the receiver is pictured in Fig. C.

Before proceeding further, the television investigator is reminded that the picture-modulated energy output of the I.C.A. "Amateur's Television Projector" may be used to modulate the carrier of an amateur transmitter, in the usual manner.

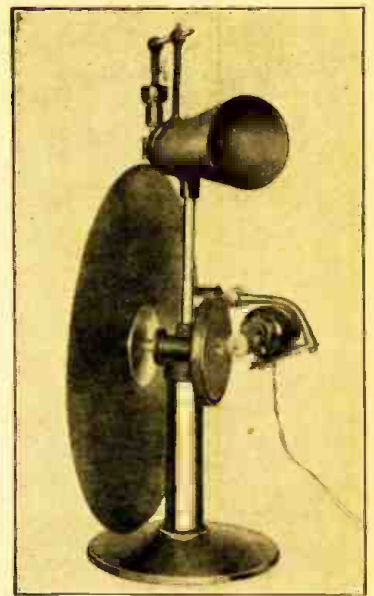

Fig. C

The simplified design of the receiver. In later models, gears replace the friction drive shown. The cone serves to "mask" the image.

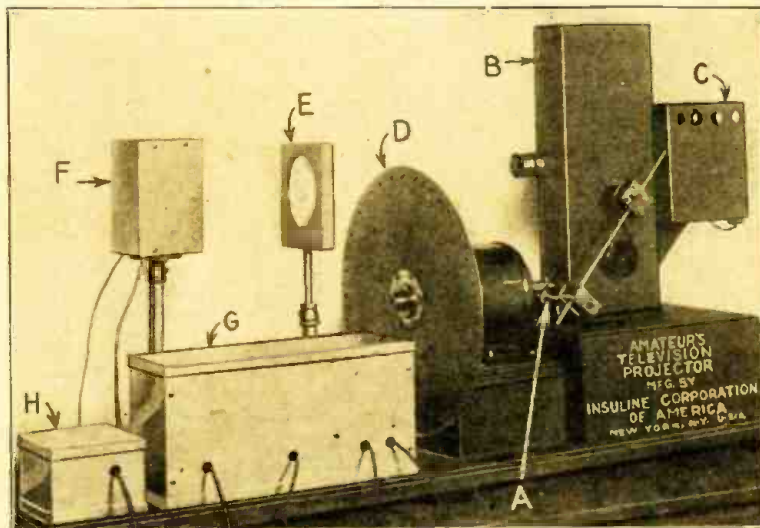

Fig. B

Transmitter, rear view: A, reduction gear; B, reels; C, exciter lamp; D, scanner; E, lens; F, "PEC"; G, amplifier; H, "phaser."

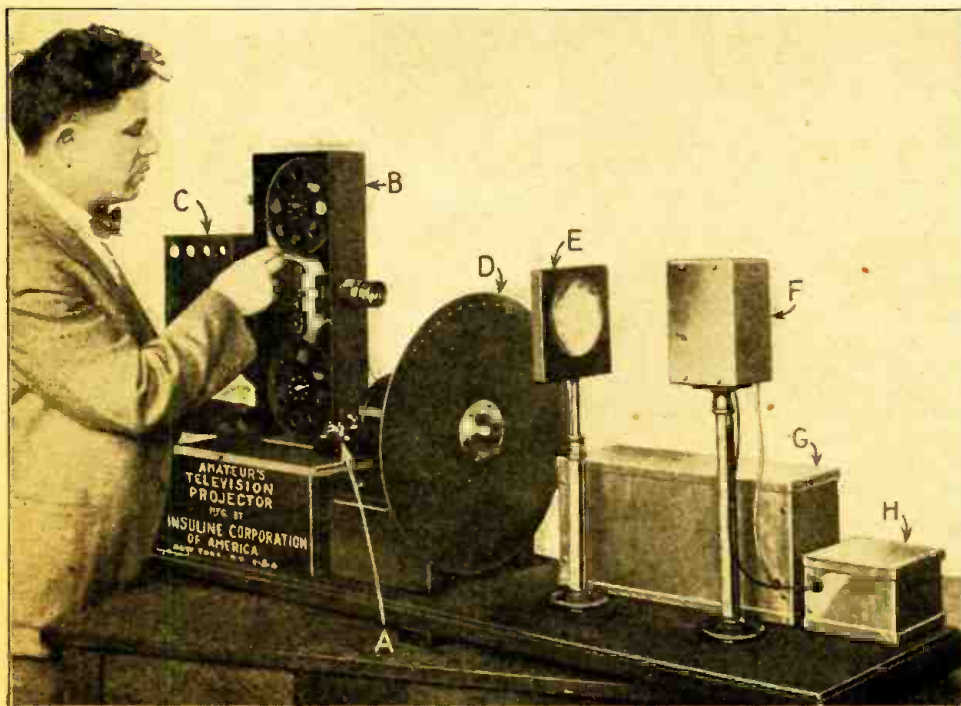

Fig. A

Front view of transmitter: A, reduction gear driven from rear end of motor shaft; B, reel housing; C, exciter lamp; D, circle-scanner; E, lens (without mask); F, photoelectric cell; G, television-frequency amplifier; H, phase reverser.

Special Disc Provided

The method of scanning employed at the transmitter is worthy of special mention. The 16-in. aluminum scanning disc has the holes arranged in a circle for film-picture projection; horizontal scanning, from left to right, is thus accomplished, while the vertical scanning is obtained by the continuous motion of the film in the projector.

The speed of the film downward through the projector must therefore bear a definite relation to the speed of the scanning disc. Each "frame" must be scanned from left to right 48 times. Instead of having 48 holes in the disc and revolving it once for each frame, we have a 24-hole disc and revolve it twice as fast. For a given size of projected picture, this permits the use of a much smaller disc than would be necessary if 48 holes were employed. Silhouettes reproduce much more easily than halftones.

(For "stills," it is necessary to adopt spiral scanning; and for this purpose spiral scanning-holes are provided in another disc.)

"P.E." Cell and Lamp

Light to actuate the "Insuline" potassium-magnesium, gas-filled photoelectric cell is obtained from a 500-watt, special ribbon-filament mazda stereopticon lamp. Its rays are concentrated in a beam on the film by a concave mirror, as indicated in Fig. 1.

Rotation of the transmitting scanner is obtained by mounting it directly on the shaft of a 1/10-h.p. synchronous motor, rotating at 1800 revolutions per minute. The film is driven by this motor, through being connected to it by an eight-to-one reduction gear; thus moving the film at the rate of 15 frames per second.

An optical focusing system is mounted in the front of the reel housing; a condensing lens focuses the scanned diverging rays, coming through the scanner, into the photo-electric cell.

This, a gas-filled cell, is operated at a bias just below its "glow point," for maximum sensitivity. To boost the energy picked up by the "P.E." cell to a value sufficiently high to give good contrast at the neon lamp, a 4-stage resistance-capacity coupled amplifier, including three type '40 tubes and a '12A (or '11A), has been designed; the schematic circuit is given in Fig. 2.

It is advisable to have the amplifier near the transmitter, to prevent extraneous interference from affecting the "electrical pattern"; but the output may be wired into another room where reception is obtained by placing there the receiving scanner and the neon lamp.

Connections of Amplifier

The amplifier is shielded. There is also a shielded "phase shifter," the purpose of which is to enable film positives (black on white background) or negatives (white on black background) to be "televised."

The aluminum "P.E." cell house is grounded to the aluminum shield can of the amplifier by the shielding around the leads of the P.E. cell.

Reception of the pictures we have taken

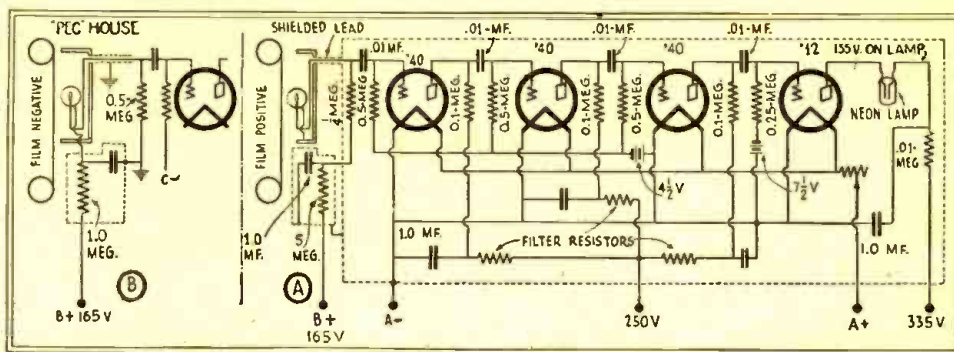

Fig. 2

The electrical circuit of the home television projector and receiver described here; the phase-shifter is connected as shown at the left (B) for use with negative films; as at the right (A) with positives. It is the resistor and condenser shown in the grounded shield (dotted lines).

such care to produce is the next and most interesting part of the program.

An 1800 r.p.m. synchronous motor, geared to the scanning disc by a two-to-one reducing worm gear (superseding the friction drive shown in Fig. C) is the driving unit for the receiver.

The same A.C. supply must be used for both motors, in order to obtain the perfect synchronization that is possible when synchronous motors are used.

Just a few more words about the receiver; a condensing lens, mounted in front of the neon lamp, focuses the light on the 16-in. aluminum scanning disc with its two turns of spiral scanning-holes, rotating at 900 r.p.m. The usual mask is used to pass one perfect picture to the observer. The use of a two-turn spiral facilitates framing by the simple process of raising or lowering the mask, with its 1 1/8 in. by 7/8 in. opening, between the scanning disc and the neon lamp.

Details of the Picture

Let us refer back to our picture. The best way to analyze it seems to be from left to right and from top to bottom as in reading a book. Then there arises the question of the number of elements into which we must divide the picture. Suppose we divide our picture into 48 lines and each line into 48 parts, remembering that the latter 48 elements are not distinctive dots but are tied together as string producing a continuous line of varying shading—that will give us 2304 elements.

Now, some people will say, "Why, you can't have any kind of picture made up of just 48 lines—that wouldn't be any good at all. You should have a picture about 10 inches high and as good in detail as newspaper pictures—say 50 lines to the inch." Well, that would be 500 lines in all. I just want to say here that 48 lines is all you will want to handle for a while.

Further, I believe that more good can be accomplished in the long run by perfecting instruments, technique, and procedure for a good 48-line picture, than by attempting pictures of greater detail. A good 48-line picture is very satisfying and, I assure you, sufficiently difficult of attainment. While excellent silhouette reproduction from film is now immediately available, half-tone reproduction requires a bit more perfection in details—such as suitable film.

With equipment such as that described above, the amateur can truly investigate and demonstrate television. Experimenting with it will prove of great value in acquainting him with many fundamentals of optics, projection, mechanics, photo-cells, light sources; and, lastly, it will give him a technique which will become more and more valuable.

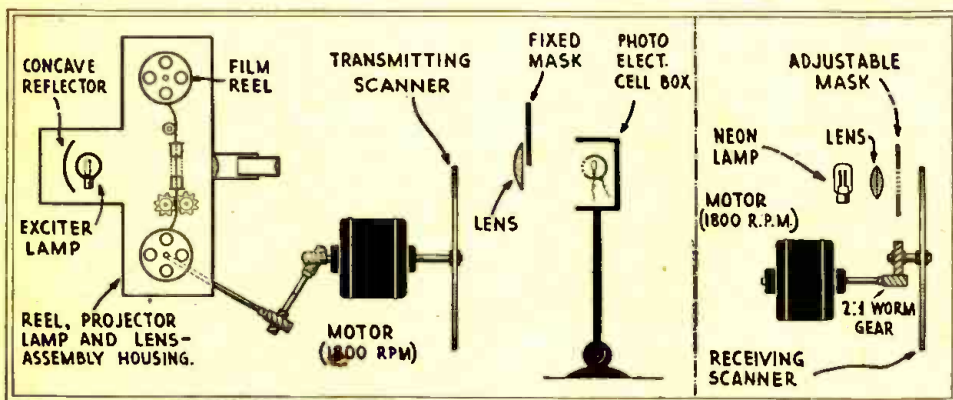

Fig. 1

Arrangement of apparatus illustrated in Figs. A, B and C; projector at left, receiver at right.

Why Is Code Used?

By J. E. SMITH*

"WHY should I bother with the code? The radio telephone will eventually be used exclusively in handling communications by radio." Such is the opinion often expressed by persons interested in radio, who feel that mastering the code is just a waste of time.

In theory, the telephone should be the ideal method of communication. It permits one person to converse directly with another, without the double translation process of the code message. And yet after eight decades (or since Samuel F. B. Morse in-

vented the telegraph or simple method of making and breaking a circuit as a means of flashing intelligence) nothing has yet appeared to replace the telegraph code. Dots, dashes and spaces constitute the most accurate means of flashing intelligence over long distances.

In radio the telegraphic form is preferred in most instances, except for broadcasting. The reason is simply explained! The radio telephone is a far more intricate mechanism, requiring many times as much power and costing many times more for a given

distance. Furthermore, the radio telephone is highly susceptible to static and other interference. The spoken message is relatively inaccurate, because of faulty pronunciation, strange words, nervousness and so on. On the other hand, the radio-telegraph transmitter is simple, compact, highly efficient, and relatively inexpensive. The telegraph messages are precise and accurate. Telegraphic signals cut through atmospheric disturbances with surprising ease. And there are other features overwhelmingly in

(Continued on page 49)

* President, National Radio Institute.

New Radio Devices for Shop and Home

In this department are reviewed commercial products of most recent interest. Manufacturers are requested to submit descriptions of forthcoming developments.

HAMMARLUND "MODEL M" GANG CONDENSER

TIME has been the acid test for the "battleship" type of gang condenser, presented some time ago by Hammarlund Mfg.



Fig. A

The two-gang "Model M" Hammarlund battleship-type tuning condenser, designed for lightness and compactness.

Co., New York City. Important improvements in this unit are indicated in the new "Model M" construction here illustrated.

Light weight has been obtained by die-casting the reinforced ribbed frame and $\frac{3}{8}$ -in. shaft. The rigid rotor and stator sections are also aluminum.

Other details are as follows; Rotor connection is made through wiping contacts of phosphor bronze; power factor is only 0.4; bakelite insulation; individual or group shielding may be used; matching is obtainable up to plus or minus $\frac{1}{2}$ -mmf. at low capacity setting and 1.0 mmf. at the high; made in two, three, and four-gang styles; maximum capacity, 370 mmf., and minimum 18 mmf.; equipped with equalizers having maximum of 25 mmf. and minimum of 2 mmf. Approximate capacity variation obtainable is indicated in the accompanying graph.

The designer of airplane and automotive equipment should find this construction to have advantages in addition to those that appeal to the designer of standard broadcast equipment.

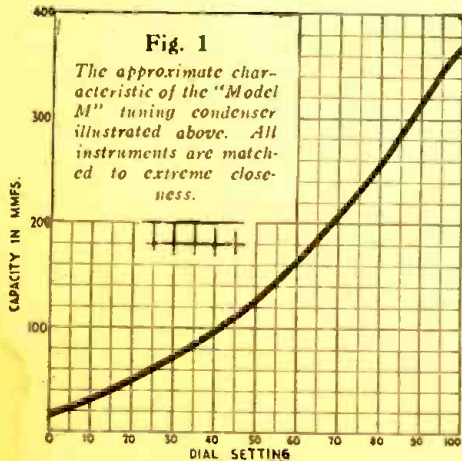

THREE NEW TWO-VOLT TUBES

UNTIL recently, the three-volt '99-type tube has been relied upon for operation of portable receivers from dry cells, the earlier 1.1-volt tubes having been compara-

tively limited in acceptance. In Europe, however, two-volt tubes have long been standard (as well as four- and six-volt types) for even storage-battery operation.

The RCA Radiotron Company has announced three new "Radiotrons" designed for two-volt supplies; and having certain features which evidence that they will find special use in portables for airplane use and other purposes where lightness and sturdiness of equipment is essential. They will interest automotive radio designers.

The three new tubes are:

(1) A general-purpose tube, with a plate current of 2 milliamperes at the maximum plate potential of 90 volts and a grid bias of 4.5 volts. Its plate resistance is 12,500 ohms, amplification factor 8.8 and mutual conductance 700 micromhos. The grid-plate capacity is 6 mmf. (Type UX-230).



Fig. B

Left, a Type UX-231, the new two-volt power tube. Right, a UX-232, two-volt screen-grid tube (the envelope removed to show construction).

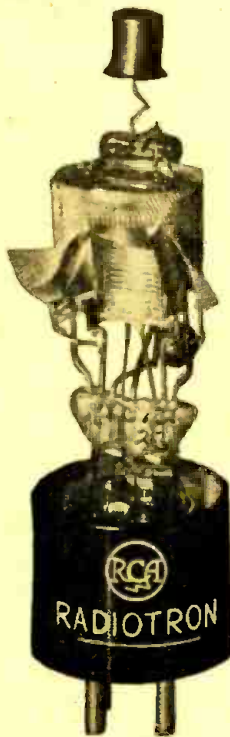

Fig. C

(2) A screen-grid tube with a plate current of 1.5 milliamperes at a maximum plate voltage of 135, with a control-grid bias of three volts (negative) which permits a larger swing. The plate resistance is 800,000 ohms, amplification 440, and mutual conductance 550 micromhos. The grid-plate capacity is only one-fiftieth of a micromicrofarad, maximum. (Type UX-232.)

(3) A power output tube, with a plate current of 8 milliamperes at a maximum plate voltage of 135, with a 22.5-volt bias on the grid. This tube has a plate resistance of 4000 ohms, amplification factor of 3.5, and a mutual conductance of 875 micromhos. It is rated at 170 milliwatts undistorted output. An output unit is not indispensable for connection to the reproducer. (Type UX-231.)

All these tubes fit UX sockets. The first two draw 60 milliamperes of filament current at a voltage across the terminals of 2.0—a value which should be strictly maintained. The power output tube takes a filament current of 150 milliamperes.

It is recommended that the general-purpose tube, though designed especially to avoid microphonic qualities, should have a cushioned socket. For its use as a detector, a plate voltage of 45 is recommended.

A warning is given against obtaining screen-grid voltage for the screen-grid tube by the use of a high resistor in series with a high-voltage tap; because of the variation in the current drawn by this element in different tubes. Complete isolation of various circuits must be accomplished, as with other four-element tubes on the market. Transformer rather than impedance coupling for R.F. stages using this tube is advised.

AUTOMATIC LINE VOLTAGE REGULATOR CLAROSTAT

THIS is the rather long but explanatory name for a new product of Clarostat Mfg. Co., Brooklyn, N. Y. As shown by the illustration (Fig. D), the device is to be connected between the screw-plug (or wall plate) and the prong-plug halves of the regular line-connection plug on A.C. sets.

The resistance of the unit (Model A, for sets rated below 100 watts; Model B, above 100 watts) varies to compensate fluctuations of the line voltage, and is said to follow these voltage changes as rapidly as the needle of a dead-beat meter. With varying line voltages, the voltage applied to a 100-watt set through a "Type A" unit will not plot a straight line but will be, approximately, as follows:

Without unit	105	110	115	120	130
With unit	100	104	108	110	118

Over-all dimensions: $2\frac{1}{2}$ x $1\frac{3}{4}$ in. diameter; bakelite end plates; perforated metal shell to provide ventilation. The special resistor is a wire winding (the inductance of which acts as a choke coil to high-frequency disturbances) on a mica form.

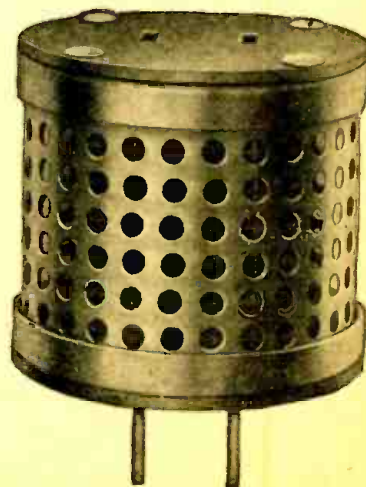

Fig. D

A new Clarostat device to plug between the house socket and the receiver, for suppressing line-voltage fluctuations in the power supply.

SHORT WAVE CRAFT

A Portable Short-Wave Set of New Design

By CLIFFORD B. HIMOE*

THE new short-wave receiver illustrated here has been especially designed for use where economy of space and weight are prime factors—as, for instance, in aircraft, small yachts, police and other cars and portable amateur receiver stations. Complete with tubes, coils and battery cable, it weighs just 7½ pounds; the aluminum case is 5 x 6 x 9 inches, and carries in a small socket-panel on top the plug-in tuning coil in actual use.

The circuit presents a novelty in its space-charge screen-grid detector; the aperiodic screen-grid R.F. stage and the transformer-coupled audio amplifier are familiar. The advantages sought in the design are compactness and simplicity of operation.

The tuning range obtained with four plug-in coils is from 14 to 195 meters—the entire band of effective short-wave communication. A longer coil, however, has been tested out on the long-wave band, around 1000 meters, used also in official aircraft work. The circuit as shown is adopted either to a storage "A" battery, with '01A and '12A tubes in the audio amplifier; or to very economical operation from dry cells, using the new De Forest 422A and 499 tubes. In the latter case, the grid biasing resistors of the screen-grid tubes are shorted out, being unnecessary with but 90 volts on the plate; these tubes, also, draw but 60 milliamperes filament current. The connections shown at the lower left in the diagram provide option in filament

supply from dry cells or storage battery.

The ingenious placement of parts, utilizing a subpanel ¾-inch below the top of the case to mount the tubes in an inverted position, reduces the length of high-frequency leads to a minimum and increases stability on the low waves.

The larger tuning condenser C1 (.0001-

mf.) is operated directly by a knob and serves as a band selector; the vernier-controlled C2 (50-mmf.) then is used for fine tuning. Regeneration is controlled by the 500,000-ohm variable high resistor (Claro-stat) connected in series between the "B+45" tap and the fixed-tickler winding L2 of the plug-in coil. The 50,000-ohm resistor,

Fig. B

The top, not the bottom, of the sub-panel of this ingeniously-designed portable short-wave set. By mounting the tubes in an inverted position from this panel, the connections are made very short, and everything is placed very compactly. The tuning coil plugs in on top, in the standard mounting prominent in the center of the sub-panel. The whole thing—except for the tuning coil, goes into a space 5x6x9 inches.

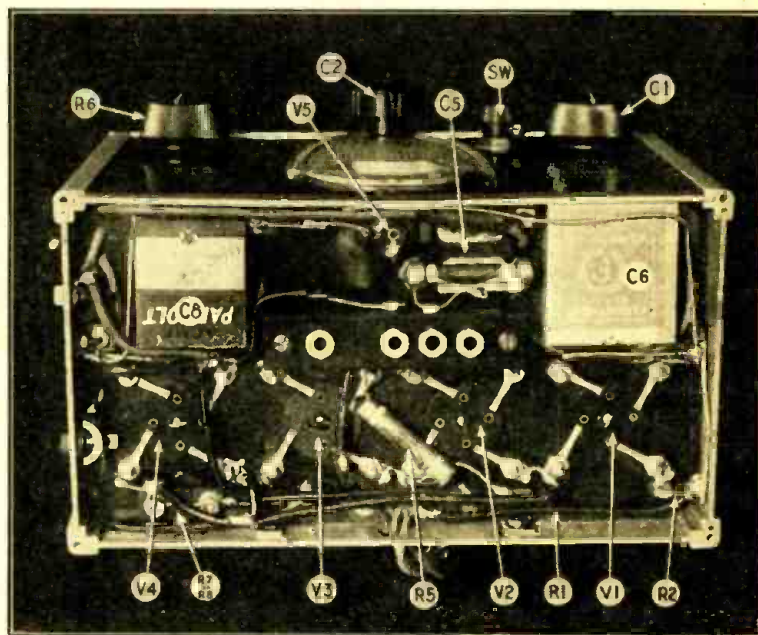
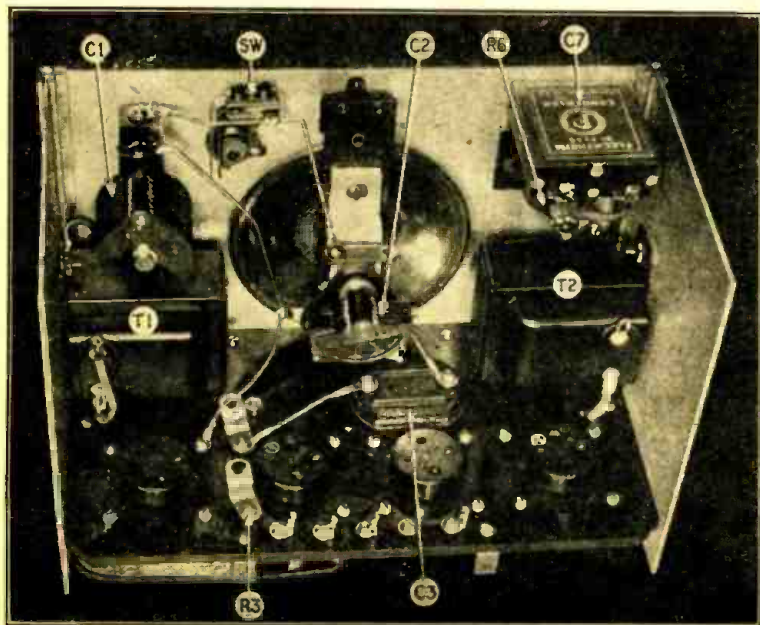

Fig. A

A view of the inside of the set, looking "up." The tube sockets are on the under side of the sub-panel; the audio transformers on the two sides of the shield. C1 is a large midget, set roughly to choose a band; its shunt, C2, with its vernier dial, permits fine tuning. There are no binding posts, cable leads being soldered direct to their terminals; but optional connections for different filament voltages are available, as shown in Fig. 1, on the opposite page. The parts illustrated may be identified by comparison with that diagram.



R5, across the secondary of the first A.F. transformer T1 prevents "fringe howl."

The 5000-ohm resistor R1 in the antenna circuit provides aperiodic coupling to any antenna without affecting the calibration of the tuning circuit. A thirty-foot length of wire has been used in laboratory tests, but other aerials will work equally well.

The interior views show how ingeniously space is utilized. The audio transformers, T1 and T2, are mounted opposite each other on the end plates of the case; the resistors and by-pass condensers on the rear. The front panel carries the two General Radio midget tuning condensers and the regeneration control R6. The battery-cable leads are soldered to their proper positions in the circuit, eliminating terminal posts.

The Hammarlund-type plug-in coils are wound with No. 18 wire for the secondaries (L1) and No. 28 for the ticklers (L2) except in the 93-195 meter coil, which has a No. 28 secondary. The windings on the two shortest-wave coils are separated ½-inch;

* Communications Engineer, De Forest Radio Co.

those on the other two, 1/4-inch. The numbers of turns are as follows, two inches in diameter.

Meters	L1	L2	Spacing (inch)
14-25	3	3	1/6
23-49	7	8	1/11
45-95	18	4	1/11
93-195	26	6	Tight

A 1000-meter coil has been made up, experimentally, having about six inches (100 turns) of No. 28 wire on a two-inch form, and a .001-mf. fixed condenser in shunt; with a tickler of eight turns. The tuning range, with the small condensers, is not great, however.

Fig. 1

The schematic circuit of the De Forest short-wave portable receiver; observe the space-charge connection of the regenerative detector V2.

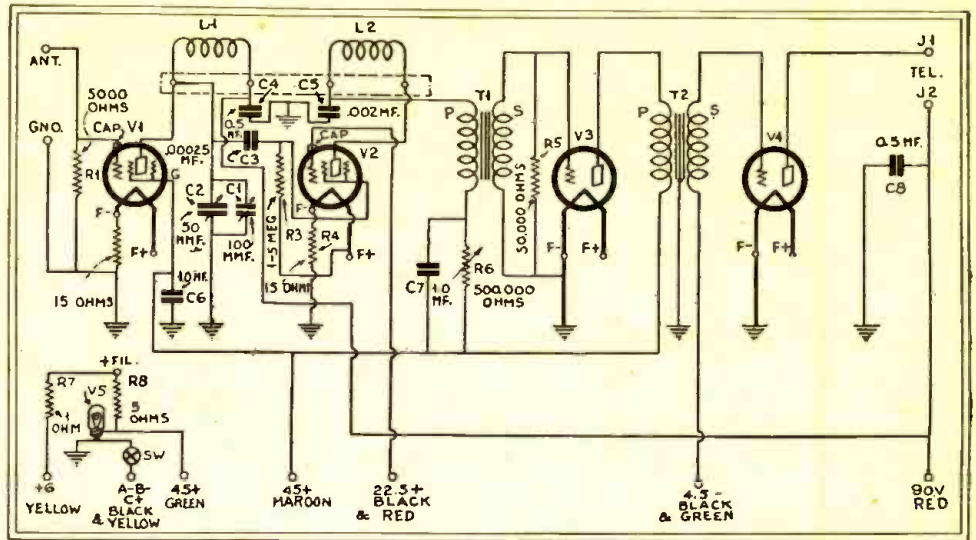

Spreading Short-wave Stations on the Dial

ONE of the problems early encountered by the short-wave fan is that of the apparent narrowness of the channel occupied by each station—unless it is very close by—which gives the effect of very sharp tuning. If the plug-in coil which we select has been designed to cover a band from 17 to 30 meters with the tuning condenser employed, there are some 763 ten-kilocycle channels between 0 and 100 on our tuning dial; and we may slide completely over a station, unsuspectingly, without moving from one division to another on the scale.

Several means have been proposed to make more accurate tuning possible. One very ingenious device, the "Automatic Tuner," was described in the May issue of RADIO-CRAFT: slow-motion dials have been made with reducing gears such that ten or more complete revolutions of the knob may be required to mesh the condenser plates completely. The simple method indicated here was well known to amateurs many years ago but it has not been suggested lately for the benefit of the new short-wave broadcast fans. Its purpose is to reduce the width of the band covered by a single coil, and thereby produce an apparent spreading-out of the stations upon the dial.

The short-wave broadcast bands occupy a comparatively narrow portion of the enormous frequency range between 12 and 100 meters. For that reason, the experimenter may be interested in the possibility

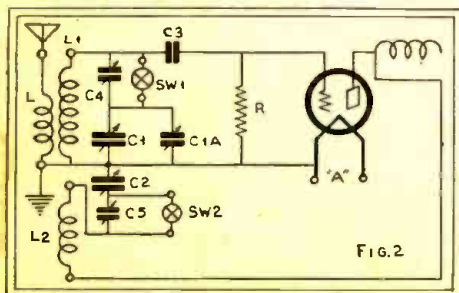

The series condensers C4 and C5, when thrown into circuit, cut down the capacity of C1 and C2; and therefore spread out station settings on the dial.

of coils, each designed to cover one of these bands with especially wide station separation, and with less regard to the code transmissions on either side of it. The method described below presents an opportunity to do so.

The number of capacities unintentionally introduced into a simple circuit is indicated in Fig. 1; in contrast to the components de-

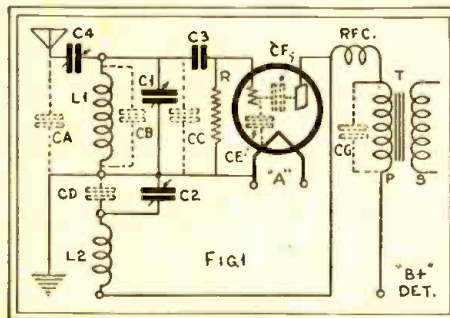

The numerous unintentional capacities found in a circuit are shown here; on short waves their effect is greater than at lower frequencies, and the tuning condenser less dominant.

signed for the specific purpose, the phantom capacities are shown in dotted lines. At high frequencies, each of these presents very little impedance to the flow of alternating current, and thereby tends to by-pass and weaken the effect of the coils and resistors. At a wavelength below that of its natural resonant frequency, a coil becomes a condenser rather than an inductance. All constructors understand the importance of having low distributed capacity in a coil; fortunately, short-wave coils require few turns, which may be well-spaced. It is also appreciated that in wiring a set we should avoid parallel leads, wherever we can. Yet, no matter how carefully a receiver is built, it has invisible capacities which assume great importance when the tuning condenser is approaching its minimum setting; and the condenser's minimum is appreciably high, in short-wave operation. To a certain extent, these facts cause the effect of the condenser's variation upon the wavelength to be less marked at the lower end of the scale;

and the crowding of low-wave stations is much less than it would be with true "no-loss" apparatus.

Series-Capacity Connections

However, if we place a fixed condenser of suitable capacity (C4, in Fig. 2) in series with our tuning condenser C1, we shall find that the capacity range of the latter is very much limited, in accordance with the fundamental law of condenser combinations; that the combined capacity of two condensers in series is less than that of either alone. The result is that we have chopped off the upper wavelengths which we formerly reached with the same coil, and spread the middle wavelengths all over the upper part of our tuning scale. The stations, therefore, have been more widely spaced on the dial.

We may, if we like, spread also the capacity variation of our regeneration condenser, which is a delicate adjustment, and has considerable effect on our tuning. The condenser C5 may be put in series with C2; provided the maximum capacity thus obtained is sufficient to produce regeneration over our entire waveband. As we have cut down on the tuning range at the upper end, it may well do so.

(Continued on page 49)

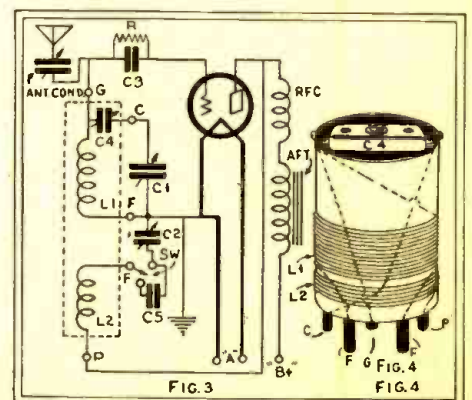

At the left, a suggested circuit using a specially-tuned plug-in inductance to cover a narrow short-wave broadcast waveband; at right, appearance of a coil with its adjusted condenser.

Modern Sound Projection (VI)

Keeping extraneous noise out of sound-on-film, with tips on trouble shooting and patching sound film

By E. C. BRINKMEYER

THE results obtained by a projectionist, who has sufficient interest in his job to do more than act as a mere machine attendant, will not only show noticeably in the box office but ultimately in his employer's satisfaction and finally in the pay envelope itself. A projectionist will always do well to study his particular equipment; and master all its little tricks and problems before he has to meet them, rather than be bewildered when the emergency faces him. One of the things a projectionist can do, to keep his sound of the highest quality possible, is to remove, and keep removed, all extraneous noise from his reproducing equipment.

Electrical Connections

Corrosion is one of the common perpetrators of unwanted sound. Soldered joints which have not been wiped clean of flux will become corroded, and covered by a flaky insulating substance. (It might be said here that, though flux is permissible for soldering many of the connections incidental to sound projectors, it should never be used in the construction or repair of any amplifier circuit. This in itself will constitute a source of noise, no matter how carefully the joint is cleaned.) Corrosion will occur also on socket prongs, filament switches, fuse blocks, jacks, sliding contacts, such as rheostats. This may be removed by using a cloth moistened with a light oil; the oil being removed with another cloth and alcohol.

Loose connections also prove unwanted guests. Tube-socket prongs may not be making positive contact; and vibration will cause a sputtering noise or, perhaps, the sound will die away altogether or come on intermittently. Cleaning these contacts and carefully bending the socket prongs to their normal positions will eliminate this trouble.

Fuses loose in their blocks, contacts loose on switches, gain controls, fader rheostats, etc., may also cause trouble; and the little time required to clean and adjust them will never be missed.

Storage batteries that do not receive the proper attention will produce a variety of unwelcome noise. Keep your batteries scrupulously clean and constantly charged; and maintain the liquid at the proper level by regular replacement of distilled water. Keep battery connections tight. It is a good plan to smear a small amount of vaseline over storage-battery contacts. "B" and "C" batteries will cause a peculiar frying noise when they start to deteriorate; and even a new, but defective, battery may act in the same manner. Replacement is usually necessary.

The Tubes and "PEC"

Some method of testing tubes should be adopted, to see that they are functioning in the proper manner at their normal voltages. Occasionally we run across a "microphonic"

tube, which usually produces a howling or ringing noise, when subjected to physical movement such as vibration or tapping on the glass of the tube. Sometimes, however, there is no external source of vibration discernible, and the tube produces the noise

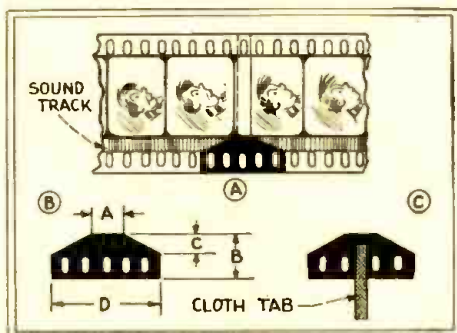

Fig. 1

The most satisfactory way of patching sound film to avoid introducing noise is shown above. Directions and dimensions are given in the text.

apparently on its own. Sometimes you may be relieved of the trouble by switching the tube to another position. In the Western Electric equipment, a microphonic "W. E. 239-A" tube, which cannot be used in the photoelectric cell amplifier, may be successfully used in the "41-A" amplifier.

The photoelectric cell, sometimes referred to as the "PEC," is the "eye" of the sound-on-film reproduction. It is necessary, of course, to have the PEC enclosed in a light-proof housing containing a window; so that the cell may collect the light variations made by the sound record on the film without interference from any other source whatsoever. If there are any holes in the housing, or if light is entering through the door glass of the sound-head, find some means to prevent the light from passing these parts.

The new Western Electric universal-base equipment is provided with a separate PEC housing (instead of the PEC being installed inside the amplifier housing, as was the practice before). The new PEC compartment contains a positive binding-post connection with a set-screw; a small round hole is left in the housing, so that a screwdriver may be inserted to tighten or loosen this set-screw. If there is any chance that any light is entering here, it would be a wise plan to insert a cork in this hole or provide other suitable means of preventing light from entering the compartment.

Miscellaneous Troubles

If you have an A.C. hum in your set and you have traced out everything else, see if some light from your booth lamps is not finding its way into the PEC.

The sound track must be perfectly in line with the optical train of your sound system, to prevent extraneous noise coming from frame lines or sprocket holes.

In some localities the voltage supply to the theatre varies and, at times, there is an excess of voltage which will affect the equipment, causing tubes (especially the A.C. heater type) to become noisy and causing a strain in general and perhaps breakdown. If you have no means of controlling such circumstances, your only alternative is to keep spare tubes and critical parts handy in case of trouble.

Grid leaks and fixed resistors are sometimes noisy. Replace defective units.

All wiring in sound reproducers should be so run that it will be impossible for current to be transferred by induction between wires running near or parallel to one another.

Patching Film

Last, but not least, of all are the patches, in sound on film. A patch on a sound film will introduce extraneous noise into the reproduced sound, unless the patch has been treated in some manner that will obscure it. The greatest of care should be exercised in the making of a "Movietone" splice. Cement smears, fingerprints, dirt spots, mutilated emulsion, poor alignment, provide effective sources of objectionable noise.

It is possible to eliminate splice noises by applying some opaque coating over the splice, in such a manner that it shuts off, and turns back on, gradually, the light entering the PEC. This requires, however, extreme care and patience as well as time; as it is usual to "paint out" with an opaque lacquer or india ink. This method worked

(Continued on page 51)

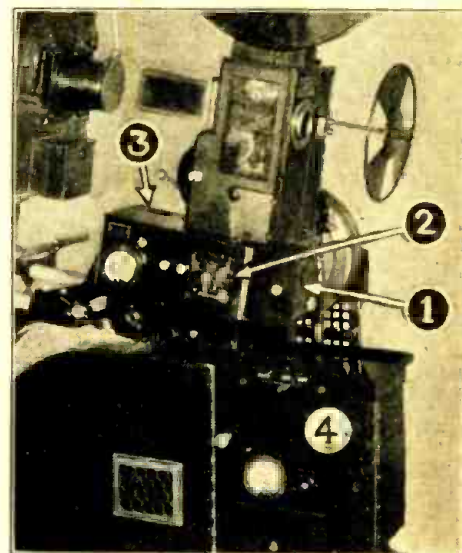

Fig. A

The Western Electric universal-base equipment mentioned: 1, "PEC" house; 2, sound-film feed (improved type); 3, lamp house, with meter; 4, amplifier for "PEC" pick-up.

(Photo Courtesy Bell Telephone Laboratories)

A Screen-Grid Superheterodyne for Motor-Car Use

The circuit and layout of a sensitive set designed for the constructor who wishes to build his own touring companion

By H. G. CISIN

THE "Automobile Portable" sketched here is a model which the writer designed in response to the widespread demand for a successful receiver of this type, for which a great number of "radio-minded" car owners have been seeking. The schematic circuit is Fig. 1; and Fig. 2 shows one very convenient method of mounting the receiver chassis under the instrument board of a car. Whether the automobile installation is to follow this plan must be determined by the design of the car itself and the convenience of the owner. Fig. 3 is the layout of components.

This receiver is one of high sensitivity and consequently for distant reception which calls for maximum amplification, it will generally be found necessary to stop the mo-

Fig. 3

The layout given here is especially compact and introduces no complications. Wiring is run on top of the baseboard in the most direct fashion. Each stage is surrounded by its shield can.

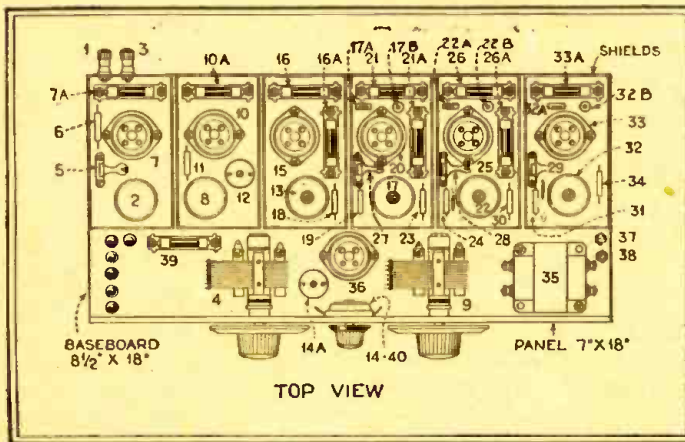

tor of the car. For DX work, therefore, it is desirable to consider this set principally as a high-quality portable receiver, serviceable during halts. Local operation, however, may be available during the run; and this is a matter in which the thoroughness of installation is important. The receiver itself is completely shielded; the interference to be guarded against being that picked up by the antenna.

40. Following this are three stages of screen-grid intermediate frequency amplification, a second detector, and a semi-power stage of audio giving suitable volume for a car's interior, or ordinary room.

The input circuit of the first detector 7 is tuned to the broadcast station's frequency; tube 10 is the oscillator. Both are 01A's. 15, 20, 25 are 115-kc., intermediate-frequency screen-grid (type '22) amplifiers. 33 is the

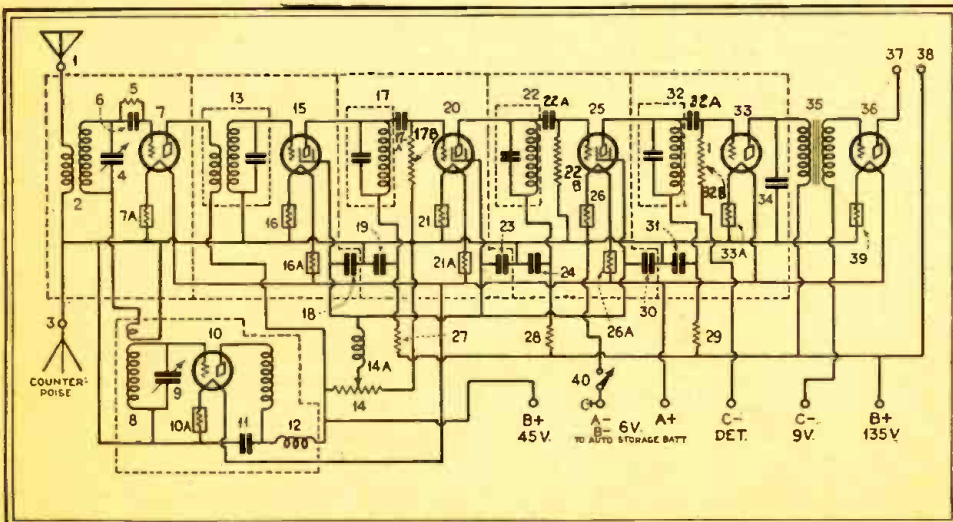

Fig. 1

This receiver, with three stages of intermediate-frequency, screen-grid amplification, will build up any signal to the point necessary to give volume suitable to the '12A output tube (36) which is favored in the latest automotive radio designs.

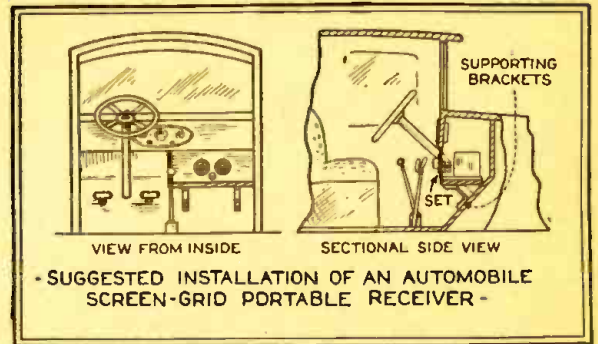

Fig. 2

The receiver may be located wherever desired; but standard practice favors this arrangement.

(In this connection, the subject of ignition interference and shielding and car antenna installation has been discussed at some length in articles appearing in the February and March issues of RADIO-CRAFT.—Editor.)

The Circuit Arrangement

The circuit, as will be seen from Fig. 1, is a superheterodyne with two tuning dials, controlling condensers 4 and 9, and a volume control 14 comprising also a filament switch

second detector, also an 01A; while 36 is the only A.F. amplifier, for which a '12A tube is recommended.

Each stage of the A.F. amplifier is shielded by a copper can.

The intermediate-frequency output of tube 7 is coupled through the R.F. transformer 13 to the first intermediate-frequency amplifier 15; the secondary of unit 13 is tuned, through a limited frequency-range, by the small (screw-adjustable) variable condenser built into the unit and shown in the diagram. Tuned-impedance coupling is used in the remaining stages of I.F. amplification. All the inductances used in this set are of the "interchangeable" type and plug into receptacles (standard tube sockets). Tuning and oscillator variable condensers are of .00035-mf. capacity with "Midline" plates.

The input circuit of oscillator 10 is tuned from 180 to 460 meters, to heterodyne the desired signal to an intermediate frequency of 115 kc. The selectivity obtained by this circuit arrangement is not sufficient to give interference-free performance in some localities, where a regular outdoor antenna is to be used in conjunction with a home installation. However, exceptionally satisfactory results may be obtained when a short wire or a metal screen in the car constitutes the pick-up.

Volume is controlled by adjusting the resistor 14, thus varying the screen-grid potential of tubes 15, 20 and 25 from 0 to 45 volts. Resistors 16, 21, 26 reduce the filament current and develop the negative biasing potential required for the control-grids. To increase the amplification obtainable from them, and to prevent circuit oscillation, flexible resistors 27, 28, 29 are inserted in the plate circuits of these tubes as "circuit isolators."

Construction of the Set

Condensers 4 and 9 are mounted symmetrically on either side of a vertical line scribed on the back of the panel. The condenser-shaft holes are drilled on the horizontal center line; two additional mounting holes must be drilled for each condenser. The combination volume control and switch is located on the vertical center line, about two inches from the bottom of the panel. Five holes should be drilled for fastening the panel to the baseboard, with the aid of right-angle brackets.

The six tube sockets are mounted on pieces of sponge rubber to prevent tube vibration. (The rubber pads are cut to the shape of the sockets, and two holes are punched through each for the mounting screws. The fastening nut should not be drawn up too tight, and should be soldered in place after the correct adjustment has been made.)

Where the wiring is run through the

shields, spaghetti wiring should be used to prevent short-circuits. Control-grid leads must be kept as short as possible.

An Amplion "Lion" speaker, type "AC-21" has been used by the writer in the car installations he has made.

Coil Data

Coil No. 2 consists of 17 primary turns of No. 36 or 38 enameled wire and 110 secondary turns of No. 30 enameled wire on a tube $1\frac{1}{4}$ inches in diameter and $2\frac{3}{8}$ inches long. The outer leads of this coil unit are the aerial and grid leads; as both coils are to be wound in the same direction. Primary and secondary are spaced $1/16$ inch. Coil No. 13 is wound on a tube 2 inches in diameter and $3\frac{1}{2}$ inches long. The primary consists of 85 turns of No. 40 D.S.C. wire wound on top of, and at the filament end of, the secondary. Details for this secondary are the same as for coils 17, 22, 32, it is 350 turns of No. 40 D.S.C. on a tube 2 inches in diameter and $3\frac{1}{2}$ inches long.

Coil No. 8, wound with No. 30 D.S.C. wire, has a grid winding of 80 turns and a plate winding of 54 turns, separated $1/16$ inch, on a tube $1\frac{1}{4}$ inches in diameter and $3\frac{1}{16}$ inches long. Over the grid coil is wound the 10-turn pickup coil. Coil 2 is

shunted by a variable capacity 4 of .00035-mf.; coil 13 is shunted by a "Type G" X-L Variodenser (with a maximum capacity of .0005-mf.), to tune the circuit to the intermediate frequency of 115 kc.; coils 17, 22, 32, are shunted by "Type G" Variodensers; condenser 9, a variable unit, has a capacity of .00035-mf.

List of Parts

Two .00035 mf. Hammarlund "Midline" variable condensers (4, 9);
 One Remler antenna coupler, interchangeable inductance No. 550 (2);
 One Remler interchangeable inductance, No. 612 (13);
 Three Remler interchangeable inductances No. 614 (17, 22, 32);
 One Remler oscillator inductance, No. 570 (8);
 Six Remler shielding cases, No. 720;
 Three 1000-ohm Electrad "Truvolt" flexible wire resistors (27, 28, 29);
 One Electrad "Royalty" type "B" potentiometer, (14) with filament switch attached (40) or one Electrad "Super-Tonatrol" type No. 5 (14) and separate filament switch (40);
 Two Silver-Marshall R.F. chokes, type 276 (12, 14A);

One .001-mf. Polymet small molded bakelite condenser, type SM-1258 (34);
 Ten .006-mf. Polymet molded fixed mica condensers, type MC-1219 (11, 17A, 18, 19, 22 A, 23, 24, 30, 31, 32 A);
 One Thordarson audio transformer, type R-300 (35);
 Thirteen Eby sockets, UX-type (2, 7, 8, 10, 13, 15, 17, 20, 22, 25, 32, 33, 36);
 Eight Eby binding posts (1, 3) and others not numbered);
 One .00025 mf. Polymet grid condenser (type SM-123) (6);
 One 2 meg. Durham metallized resistor grid leak with vertical single mounting (5);
 Three 2 meg. Durham metallized resistors, type MF4-2 with tinned-wire pigtail leads (17B, 22B, 32B);
 Three Amperites, No. 1-A with mountings (7A, 10A, 33A);
 Six Amperites, No. 120 with mountings (16, 16A, 21, 21A, 26, 26A);
 One Amperite, No. 112, with mounting (39);
 Two Electrad tip jacks (37, 38);
 Two vernier dials;
 One roll Corwico "braidite" stranded-core hook-up wire;
 One can Kester rosin-core radio solder;
 One "Insuline" panel, 7 x 18 x $3/16$ inches;
 One wooden baseboard, $8\frac{1}{2}$ x 18 x $1/2$ inches.

Solving Automotive Antenna Problems

IN the May issue of Radio-Craft appeared a description of the circuit and general mechanical details of the Bosch automotive radio installation. Further information on the manner of placing the equipment in the car is given below.

Fig. 1 is a skeleton view of the car chassis, giving a clear detail of the placement of the units that comprise the receiver equipment.

Probably the first thing to draw the attention of the reader will be the use of shielding. The four, 45-volt, dry "B" batteries are placed in a shield box, with a separate cover, that is conveniently slung on the right side of the car chassis, in most cases, behind the car's storage battery, which is contained in a strong iron shield can. As previously mentioned, the entire receiver chassis is thoroughly shielded. The power leads from the set on the dash to the batteries under the car floor are run in shielding (BX cable). The low-impedance R.F. transmission line from capacitor-plate to set (what is normally called the lead-in) is run in a shielding tube. Also, the short volume-control leads from the set to the panel-mounted control unit are shielded, to prevent pick-up from the ignition equipment of the car.

The most convenient place for mounting the control unit is at the extreme right of the instrument panel, as shown in Fig. 1 (and in Fig. A in the May issue), as necessitated by the tuning control; which is a steel shaft enclosed by a tube. Universal joints at each end of the shaft permit the twisting motion of the tuning knob to be transferred up or down, right or left; and a "splined" or slotted sleeve permits the shaft to ride back and forth, without binding, as the dash and instrument board twist and turn slightly as the car rolls along. Because different cars will necessitate vary-

ing lengths for the driving shaft, it is shipped "oversize," and cut to the desired length.

Although the reproducer is shown in Fig. 1 mounted directly on the steel case of the receiver chassis, it is possible to place this unit in any other part of the car. This is a late development in design; many car owners consider it better to have the reproducer mounted on the inside of the roof, and

at the rear. For this purpose, there is available a mounting bracket which fastens to the overhead bows. That there may be considerable point in so placing the reproducer to keep it out of earshot of the driver is evident when we consider that (as Mr. H. Gernsback has pointed out in his editorial in the previous issue) a few state authorities offer objections to automotive

(Continued on page 51)

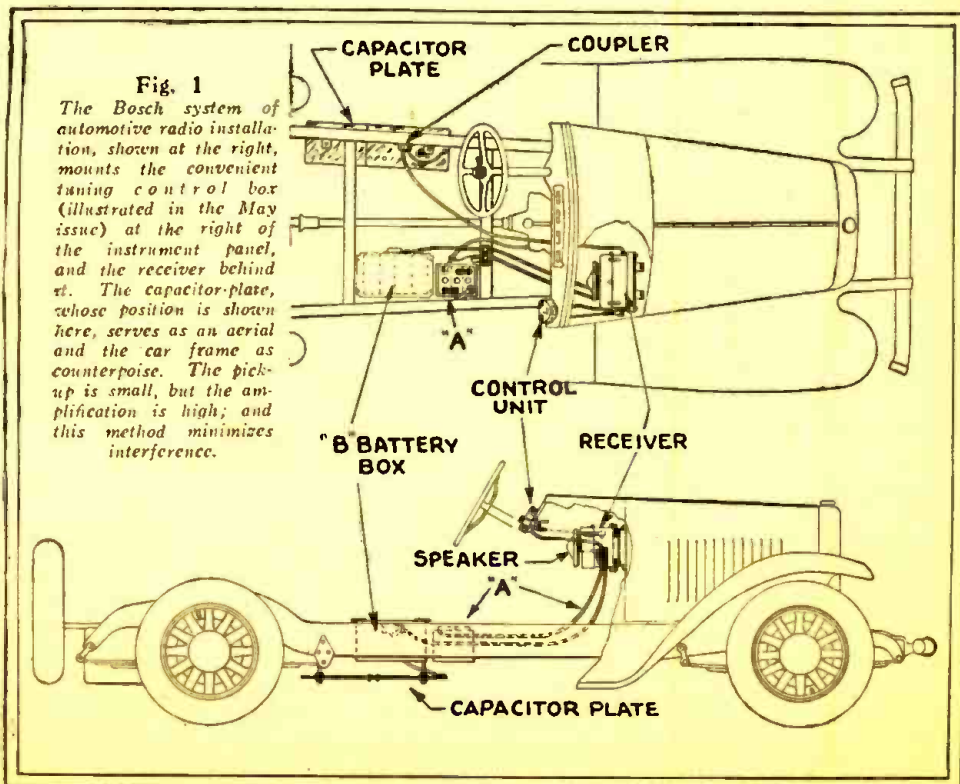

"B" Power from a Storage Battery

A practical and inexpensive method of obtaining 110-volt alternating current, with which to operate electric sets or other equipment requiring an A.C. input, is described here. The principle is a familiar one in electrical practice.

By L. B. ROBBINS

THE following idea is admirably adapted to localities not provided with electric power, such as camps, under conditions where "B" batteries are considered too expensive. It will provide A.C. current at 110 volts, suitable for feeding the input to a "B" eliminator, and

transformers and a variable input from the battery, high-voltage currents can be built up for operating amateur transmitters using '10 or '50 tubes; voltages as high as 500 have been reached.

The idea (as shown in Figs. 1 and 2) is simply that of taking 6-volt direct current

device has been tested out and is now passed along for the benefit of those who have been waiting for just such a feature.

Mount the motor on one end of a piece of heavy plank as the base (Fig. 1). Any good 6-volt D.C. motor will do so long as it will turn up to at least 2,000 r.p.m., is shunt-wound, draws about 15 watts and will run steadily for two or three hours at a time, without heating. New and rebuilt motors of similar specifications can be purchased for around five dollars.

Arrange at one side of the motor a rheostat; to which wire the "A—" lead from the battery. Also lead this to a S.P.S.T. switch near the pulley end of the motor. Wire the other side of rheostat to one motor terminal. Then wire the other motor terminal back to the battery "A+," with a switch in the line as shown. On the opposite side of the motor place a miniature lamp socket with one side also wired to the "A+" motor terminal. Remove the pulley from the motor shaft and you are now ready to construct the converter.

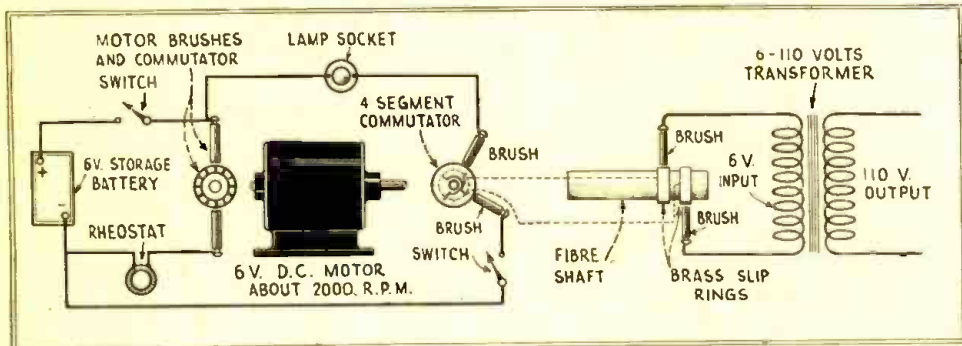

Fig. 2

Operating arrangement of the rotary converter. If the output supply is incorrect, the motor or transformer probably has the wrong constants. Test output with an operating load.

take it all from an ordinary 6-volt radio storage battery or the starting battery from the car or power boat.

Altogether, this converter should not cost more than ten dollars and, with a little care in building, it will give fluctuation-free alternating current, drawing approximately 4 amperes from the battery. By suitable

from the battery and, by means of a rotary converter, converting it into alternating current slightly less than 6 volts; and then stepping it up to the desired voltage.

Although the diagrams may at first appear complicated, the circuit is really simple and good results depend only upon careful workmanship and careful adjustment. This

Commutator Construction

This consists of a second commutator removed from an old motor or generator and containing an even number of segments; preferably four, for this purpose. It should be about 1½ inches in diameter and ¾-inch wide. The shaft hole will in all probability be 9/16-inch in diameter, the usual size for

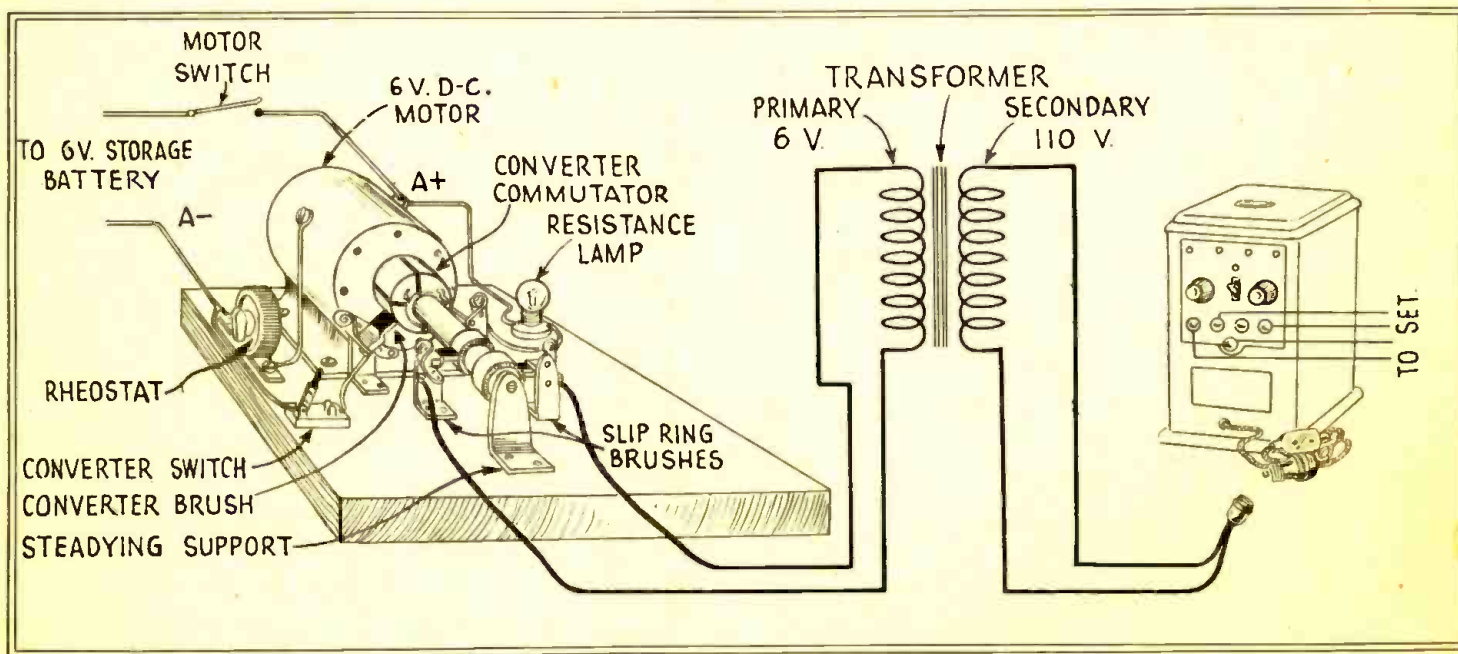

Fig. 1

Picture diagram of the rotary converter, designed to change 6-volt direct current into 110-volt alternating current. The output of this unit must be rectified and filtered as with any other A.C. supply. A high-resistance voltmeter, designed for use with "B" eliminators, should be used to test the output voltage with all apparatus in operating condition.

this size commutator. Solder a jumper wire to the front face of each two opposite segments (as shown at the left of Fig. 3); 1 to 3 and 2 to 4. If the commutator contains 8, 16 or 32 segments, band enough together so that four segments result, and then jumper these (as shown at lower left, Fig. 4) as just described. In any event you should have four distinct sections of the commutator, with opposite sections connected by jumper wires.

Next, get a 3-inch piece of round fiber rod, $\frac{5}{8}$ -inch in diameter. Turn down one end on a lathe carefully for a distance one-half inch longer than the width of the commutator, so that it will make a driving fit into the latter. Then drill a hole in the center of the rod to make a snug fit over the motor shaft with a tapped set-screw hole down into it near the end. Press the commutator over this fiber shaft and test for trueness in running. No wobble should be evident (center, Fig. 3).

At the opposite end of the fiber shaft fit two slip rings, turned out of brass $\frac{1}{2}$ -inch wide. These may be $\frac{7}{8}$ -inch outside diameter; the inside diameter should be a $\frac{5}{8}$ -inch drive fit, as indicated in Fig. 3. Space them about $\frac{1}{4}$ -inch apart. Then connect ring A to one commutator jumper with an insulated wire and ring B to the other jumper. This may be done by drilling a small hole or slot through the thickness of the ring parallel and next to the shaft, running the wire through, and soldering to the ring. The wire to ring B must of course be insulated from ring A, so that no contact is possible. Snap a rubber band about the wires and the shaft to prevent them from flying off when the shaft is revolving. Lastly, drill a small center hole in the extreme end of the shaft. If all holes are drilled accurately and the shaft is straight it should run steady, even when it is fitted over the motor shaft and the set screw turned down. A slightly flattened spot on the motor shaft will assist the set screw in holding.

Brush Details

Get four "third" brushes and holders from Ford generators and file off the lugs on back of the holders and drill two holes in each where indicated in detail sketch, Fig. 4. The two commutator brushes must be supported at a 90° angle to the center of the commutator; so make two supports of heavy, stiff flat brass after the pattern shown. No height can be given, because of the variation in the heights from the base

base. Brush pressure can then be readjusted by altering the spring tension.

The other two brushes bear horizontally against the slip rings at opposite sides and must be fastened to their supports, shown in detail, in a similar manner. The bolt slots allow slight raising or lowering. The desired electrical circuit is clearly shown in Fig. 2.

The steadying support (upper right, Fig. 4) is of heavy brass, similar to the other

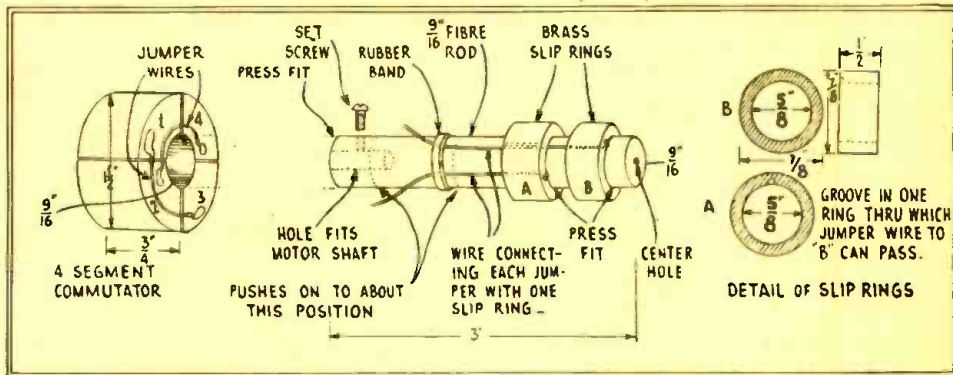

Fig. 3

Detail of the commutator of the rotary converter. This performs the same function as the commutator on a D.C. dynamo.

of shafts of various motors. The slot holes allow the bolts holding the holders to the supports to be raised or lowered, so the brushes can be arranged at the precise points to obtain the correct angle. Arrange the brushes at opposite sides of the commutator, so that the brushes will bear against the latter at as near a 90° angle as possible and in the center of segments of opposite polarity. This is fully shown in the center, lower center, and lower right sketches in Fig. 4. When the desired position is secured and the brush pressure is considered right, screw the supports to the

four; but with a tapped hole in the top, to center exactly with the small hole in the end of the fiber shaft. File a machine screw down to a point to fit the hole and then turn it in so just a steadying pressure is exerted without binding and hold with a lock nut. A drop of oil here now and then will prevent wearing the fiber. This support prevents vibration at high speed.

The Step-up Transformer

Next, wire from the open end of the switch on the base to the nearest converter brush and from the remaining lamp-socket terminal to the other converter brush. The two "slip ring" brushes go direct to the (bell-ringing type) transformer primary. Lead the high resistance transformer secondary (which normally would connect to the 110-volt lighting circuit) to the input of any good "B" eliminator.

A suitable transformer can be wound in the home workshop; but, for sets using not over five tubes, a 4-6-8-volt bell-ringing transformer of 50- or 75-watt capacity will do. Use the "0" and "6-volt" taps for the input from the slip ring leads and the 110-volt input of the bell-ringing transformer for the output. When the converter is putting 6 volts A.C. into the transformer the output should be approximately 110 volts. If it falls short, because of battery voltage drop through resistance of leads, then put the input leads to the "0" and "4-volt" taps of transformer.

Ordinarily, a 2-amp., 6-volt bulb in the lamp socket will be large enough. It passes 2 amps. to the transformer which, when stepped up to 110 volts, delivers slightly over 100 mils., sufficient for any average receiver. If more current is needed, insert a 3- or 4-amp. bulb; and the output of the "B" eliminator will rise accordingly.

For a low-power transmitter, a transformer may be wound that will deliver up to 500 volts at 100 mils.; but the input must

(Continued on page 52)

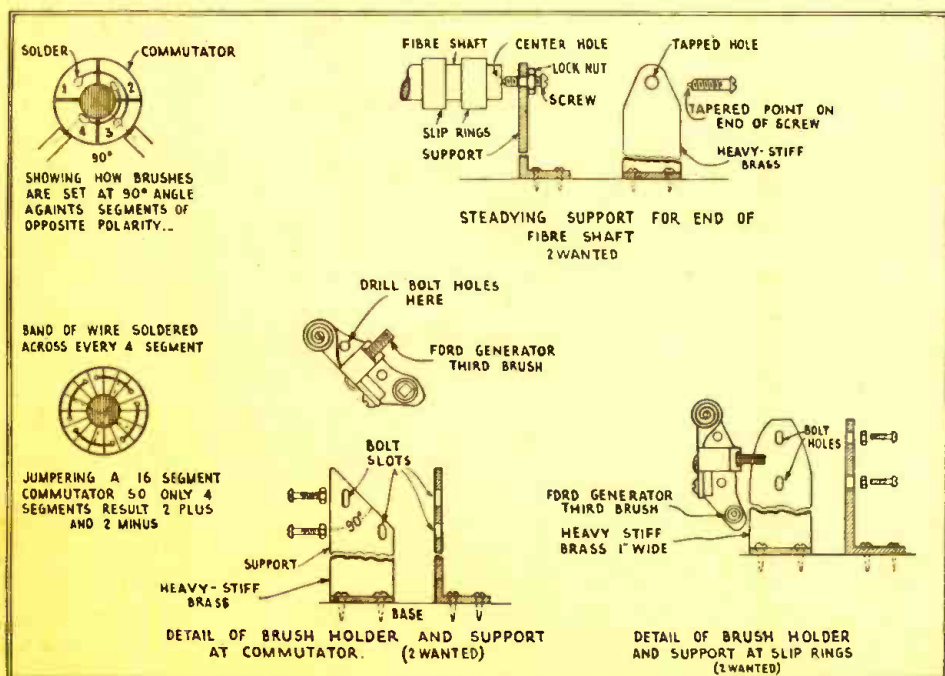

Fig. 4

Additional detail sketches of the small fittings necessary to complete the converter. A toy or bell-ringing transformer, connected "backwards," is also a vital part of the construction.

The Broad Frequency-Acceptor

This article describes the development and final design of a device which increases the selectivity and, therefore, the distance range of a receiver, while maintaining quality of reproduction

By HENRI FRANCOIS DALPAYRAT

IT has always been the opinion of the writer that the greatest loss of efficiency, in the average commercial radio receiver, is to be found in the radio-frequency system. Power detectors, power amplifiers and super-dynamic speakers are being developed and exploited as never before; while the radio-frequency system of the usual receiver, though it has changed considerably since the advent of the screen-grid tube, has not been improved proportionately. It is the purpose of this article to show not only what can be, but what actually has been, achieved in this field.

Factors of Tone

The antenna circuit, or the first stage of tuned radio frequency, in the manufactured receiver, is perhaps the most inefficient unit of the whole system. This is due largely to excessive damping effect. To begin with, there is the damping effect of the antenna primary upon the tuned secondary—the effect of a large conducting body in close proximity to a tuned circuit. (The closer the primary conductor to the tuned secondary circuit, the more magnetic lines of force are cut and, consequently, the greater the current induced in the conductor body.) The grounding of the conductor results in a path of lower resistance for the induced currents which, of course, means much greater losses. It will be readily appreciated that these factors are present in the average antenna primary system. The effect of the capacity between antenna and ground, acting as a closed absorption circuit, is negligible; since the capacity is of very low value. The losses due to the grounded-conductor effect, however, are great, and become increasingly apparent as stations are tuned in on the lower wavelengths from 350 to 200 meters. When a (relatively) high-frequency signal is impressed upon the primary and creates a voltage variation in the secondary, the tuning will appear to be

inconsistent. Because of the losses caused by the aerial, on one side, and the resistance of the tube connected across the other, the secondary will tune broadly on a strong signal and sharply on a weak one. This disparity is simply an illusion created by the fact that the secondary does not tune sharply at all. Only a circuit incorporating a minimum of resistance, and tuned to exact resonance with the incoming signal, can have a maximum voltage variation induced into it.

An obvious solution, and one frequently resorted to, is to increase the over-all amplification of the receiver; this, however, is a questionable remedy and in no way achieves the elimination of the trouble at its source. A receiver including more stages of tuned radio frequency, and working nearer to the point of oscillation, will tune too sharply; thus cutting off the invaluable sidebands. In addition to this, more power means more

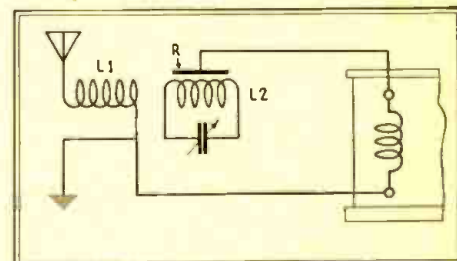

Fig. 2

The ring R makes a "leave-resonance" coupling device here (see December RADIO-CRAFT) whose sharpness depends on the width of the ring and its spacing from the coil.

distortion, considerable distortion is present. In an effort to compensate for these characteristics, the audio amplifier and loud speaker have been designed to accentuate the low notes; the result is considerable "barrel" effect and, to a discriminating musical ear, the realization that the musical scale is being artificially produced. Aside from the set owner's point of view, many lower-wave stations, good in themselves, have suffered from this effect; since owners will generally tune to higher wavelength stations where experience has taught them that tuning is broader and less power is required for adequate reproduction. Briefly, an increase in the number of tuned stages of radio frequency, while it undoubtedly increases the sensitivity of the receiver, may in no wise improve the quality of the final output.

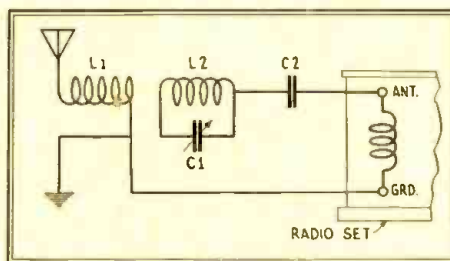

Fig. 1

The first of the author's experimental circuits.

static and local interference, hence an inferior quality of reproduction; particularly on distant and low-wavelength stations.

There are several commercial receivers on the market to-day that will bear out my assertions. In these high-power, sharp-tuning sets, the high notes predominate and, since they operate close to the point of oscil-

A Band-Pass Selector

The logical solution to the problem would be a receiver so designed that there would be equal transfer of energy at all frequencies, and with tuned coupling stages having "band-pass" characteristics. Incidentally, the ideal receiver would incorporate as few of these stages as possible, in order to retain the facility of tuning. The conclusion was reached that no more worthy objective can be found than the achievement of a quality receiver, incorporating as few tuned stages as reasonably possible, and a good band-selector assuring 10-kilocycle selectivity at any position of the tuning dial. Before analyzing the various stages of the quest, let us briefly revert to the shortcomings of the antenna (primary) circuit.

The first step in attempting to improve upon the conventional, was to increase the size of the antenna primary, L1, of a special input unit (L1, L2, C2 in Fig. 1) in order to obtain a stronger impulse and a better transfer of energy to the secondary. From 12 to 20 turns of No. 24 S.C.C. magnet wire, wound on two-inch tubing, proved best for the purpose; the secondary was wound on a tube of the same size, and a space of 1/4-inch was left between the primary and

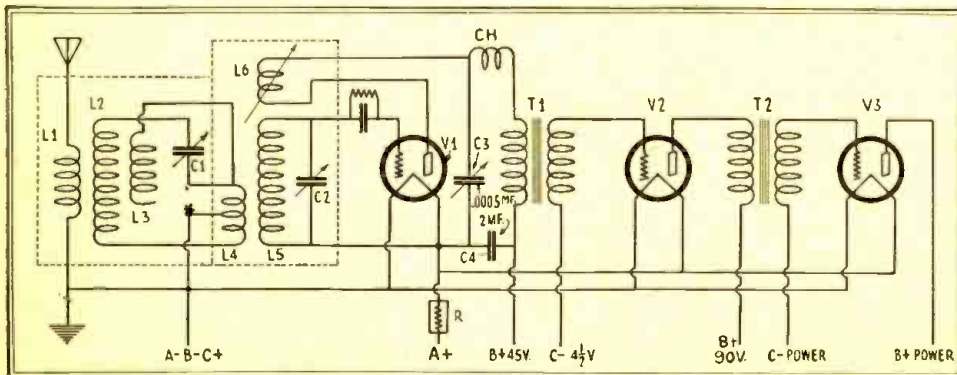

Fig. 6

With the old familiar regenerative receiver, high selectivity may be obtained without impaired quality or radiated feed-back, in this manner. The frequency-acceptor and detector must be shielded from each other, and condenser C1 connected only in the manner shown.

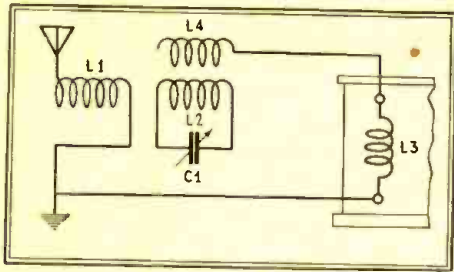

Fig. 3

Here, coil L4 replaces the ring shown in Fig. 2 as R.

secondary, so that the circuit would not tune too broadly, or the coupling be too tight, for good low-wave response. Subsequent developments proved that loosening this coupling for short-wave reception increased the response enormously, by the previously-mentioned damping effect. Before going any further, it should be pointed out that the circuit to be described was not primarily intended to supplant the antenna tuning circuit of the average receiver, but rather to work in conjunction with it.

The secondary circuit (in the test set-up used by the author) is tuned by a .00035-mf. condenser, C1. This circuit has no ground connection, and is somewhat similar to an "acceptor" wave-trap. Reference to Fig. 1 will show how this coil, L2, was connected to the aerial binding post of the receiving set through a small fixed condenser, C2, preferably of .00025- to .0001-mf. capacity. The ground binding post of the receiver was connected to the grounded end of the special antenna coil, L1. When the completed acceptor circuit was enclosed in a shielded box and grounded, the tuning was found to be very sharp and selective. The receiver functioned well, and only on the station to which the acceptor was tuned.

An Improved Arrangement

While this acceptor was a step in the right direction, it had shortcomings; chief among these was the same tendency to tune sharply on the low wavelengths and broadly on the high, that was exhibited by the receiver itself. Increasing the capacity of the coupling condenser and loosening the coupling of the primary did not help a great deal.

It was felt that little success could be expected with this type of coupling; so it was decided to try inductance-to-capacity coupling instead. The circuit evolved is shown in Fig. 2. For the capacitive plate, or collector, in this circuit, there was used a copper ring, R, 2½ inches in diameter, leaving a ¼-inch space between the coil and the ring. In this type of circuit the width of the ring determines the broadness of the tuning; using a sensitive set and a fairly long aerial, the best results were obtained with a ring 1½ inches wide. In experimenting with a circuit of this nature, however, the width of the ring should be changed until the proper value is found, depending upon set design and local reception conditions.

With a medium antenna and a conventional 6-tube receiver, a wider ring of smaller diameter is suggested. One 2 inches wide, spaced ⅛-inch from the coil, would be about right. The ring may then be reduced, thinner and thinner, until the selectivity band is the same at all frequencies.

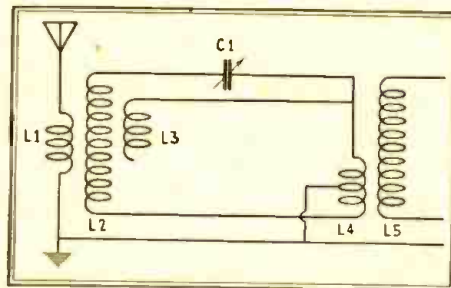

Fig. 5

A later development, best adapted to new receivers; since L4 must be tapped. L3 maintains the desired width of the band at all points in the tuning range.

In addition to its efficiency, this circuit is unique, as none of its counterparts have ever been treated in quite the same manner.

The Fixed-Ring Primary

To analyze the action of Fig. 2, let us suppose that the ring is removed and the energy collected as in Fig. 1. The acceptor will tune very sharply at all frequencies, since it has no load or resistance across it. When the metal ring is replaced, the tuning of the acceptor will be proportionately

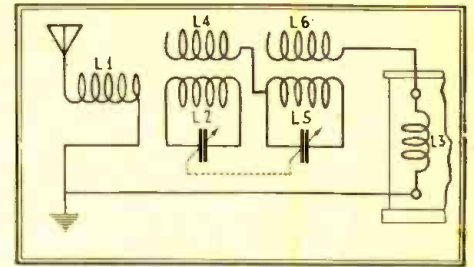

Fig. 4

Cascading two filter units and ganging the variable condensers to increase selectivity further.

broader at all frequencies; because absorption losses have been introduced into the circuit. The principal advantage, however, is that these losses apply to all frequencies except that to which the acceptor circuit is tuned. The desired signal passes without any reduction in strength, while all others are effectively blocked out. This, of course, is due to the fact that the energy induced from the coil into the low-resistance ring is reduced in voltage but increased in current.

Thus the "turn ratio" is very high; and only the signal that is tuned to maximum resonance in the coil will produce sufficient voltage variation across it to actuate the single-turn ring. (The writer did not find an improvement in conditions when using a ring that had been split to reduce eddy currents.)

As previously stated, since the losses due to absorption increase proportionately with the frequency, the tuning on the short waves will be much broader; whereas on the long waves it will remain normal as before.

The term "broad tuning" is not used in the same sense as "less selective"; what is meant is that the maximum point of volume on the dial will be extended over three or four degrees, instead of one-half to one degree, as before. Sharp tuning and selective tuning are two different things.

Continuing the analysis of the circuit, it will be seen that it acts as an acceptor wave-trap; "absorbing" from the aerial only the frequency to which it is tuned and passing all others to the ground. The maximum signal energy thus "absorbed" is applied directly to the primary of the receiving set before it reaches the ground. This is a feat that cannot be accomplished with the conventional antenna tuning system of the average broadcast receiver.

(Continued on page 53)

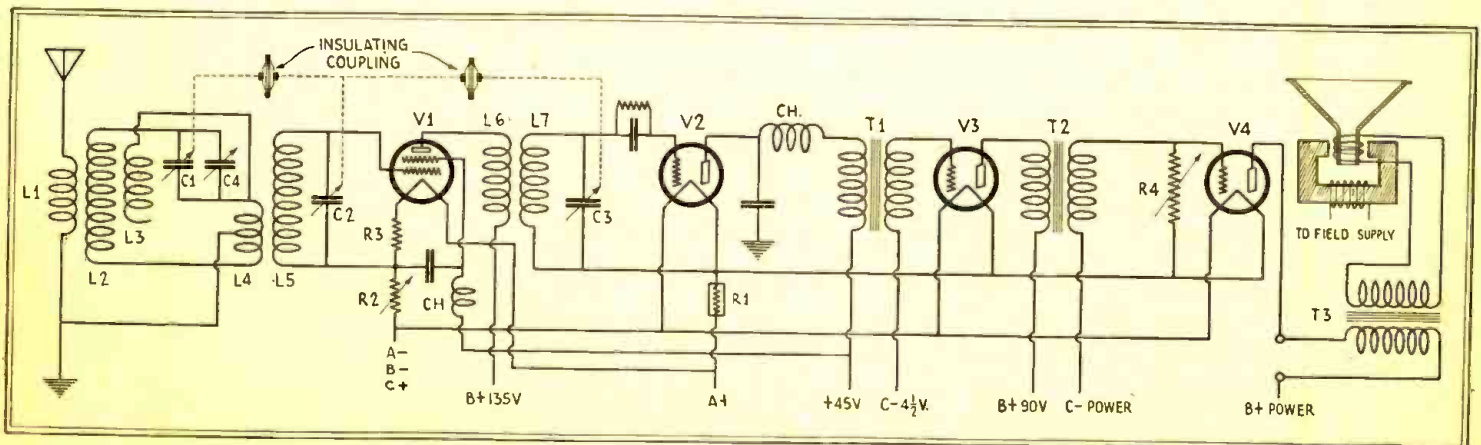

Fig. 7

A complete schematic circuit for a screen-grid receiver, incorporating the fundamental connections shown in Fig. 5. Condensers C1, C2 and C3 must be connected and insulated as shown above and described in the text. Full shielding is recommended.

The Radio Craftsman's Own Page

This page is reserved for the readers of RADIO-CRAFT; we shall be glad to hear what they are doing in the construction line—especially when it contains the element of novelty

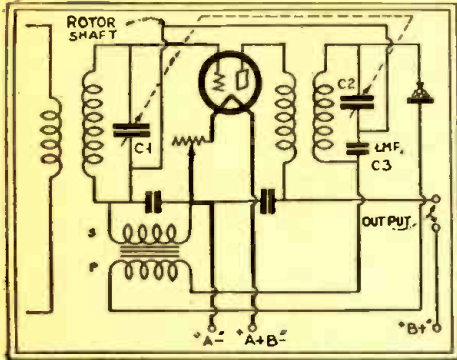

Fig. 1

The method shown above, of insulating two tuning condensers which have a common metal shaft, will interest a good many craftsmen.

TWO IDEAS FOR THE CONSTRUCTOR

Editor, RADIO-CRAFT:

There are many circuits in which a gang condenser could be used, if only the rotors were insulated. But, since the two rotors are connected by a common metallic shaft, if the condenser were hooked up in the ordinary way, there would be a short-circuit. The problem of insulating the two shafts would seem insurmountable but, by using a by-pass condenser with a capacity of one microfarad or over (as shown in Fig. 1), the trouble may be completely avoided. Note that the connections ordinarily made to the rotor of the second tuning condenser are made instead to the bypass condenser C3. Because the capacity of the bypass is so high, the effective capacity of C2 will be changed less than half of one per cent, and the ganging of the condensers will be but slightly affected. The same idea may be carried out with a three-gang condenser.

I have found that the reason why many new circuits fail to achieve the popularity they deserve is that the designers fail to pay enough attention to explaining the control of oscillation. They believe that a simple notation about "adjusting this or that balancing condenser" is sufficient to enable anyone to build the set successfully. Many set builders, therefore, will welcome the following positive control of oscillation, which I

have found to give remarkable results in certain cases where all other methods fail.

A variable resistor R (Fig. 2) such as the Volungrad, is placed across the secondary of the first or second A.F. transformer, whichever gives the best results (the second stage, of course, in a reflex circuit like that shown). This makes an excellent volume control.

C. EDWARD LINDBERG, W8CIL,
RFD. 2, Sherman, N. Y.

THE MODERN BEN FRANKLIN

Editor, RADIO-CRAFT:

A neon lamp, of the kind used for television, will light up during static storms, if connected in series with an adjustable spark gap between the aerial and the ground; the gap should be about 1/32 inch, the adjustment depending on the amount of "static" present. With a Raytheon "Kino-Lamp," it

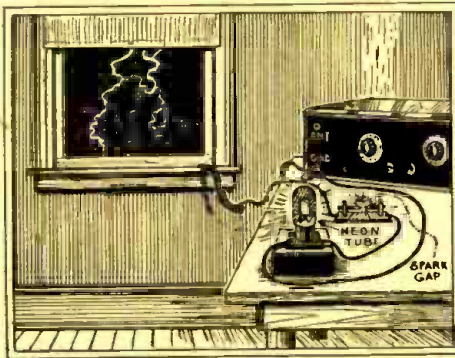

Fig. 3

Try it if you want to! It is not the lightning stroke, however, which lights the tube, but stray "static."

was possible to obtain light enough to read the print of a book held six inches from the glow.

It is best to have the spark gap between the aerial and the lamp.

PALMER STADIUM,
Box 67, Baker, North Dakota.

SLIDING SHIELD COVERS

Editor, RADIO-CRAFT:

Tiring of removing and replacing eight screws each time he wished to change coils in his "New York Times" short-wave receiver, the writer has for some time been using the arrangement shown, and finds it very convenient.

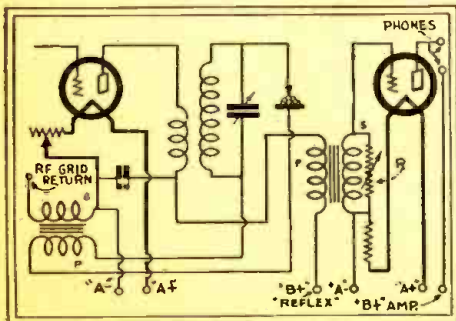

Fig. 2

Many constructors still cling to the reflex circuit and will welcome Mr. Lindberg's suggestion, above.

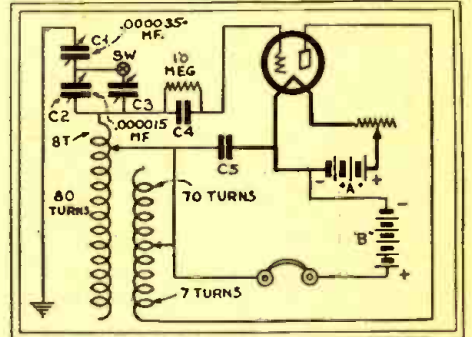

Fig. 4

Mr. Luebbers' unusual circuit is described on another page. What would you call it, anyway?

The box shields used in this set are of the Hammarlund two-compartment type. The two extra corner pieces and partition, which are unused in the original arrangement, are utilized in constructing the sliding covers.

The corner pieces are screwed to the sides of the shields, grooves inward, as shown in the picture reproduced here. From one of the original shield tops are cut two pieces, 3 3/8 x 7 7/8 inches, which are screwed permanently across the fronts of the shields. Four brackets, formed from 2 1/4 x 1/2 inch aluminum strips, are used to brace the rear corners of the shields. The sliding covers, cut from the partitions mentioned above, are 5 1/2 x 8 inches.

The most satisfactory method of cutting the aluminum for the stationary and sliding tops is by means of a sharp-pointed instrument and a straightedge, scoring the metal deeply on both sides; after which, bending it two or three times will snap it cleanly across. If tinner's snips are used for this operation, considerable work with a file will be necessary before the covers can be made to slide easily. The strips from which the brackets are formed may, of course, be cut with snips.

It may prove necessary to widen the grooves, in which the covers slide, by prying with a screwdriver; in this case, their inner surfaces should afterwards be smoothed with the tip of a knife blade. Some sort of

(Continued on page 54)

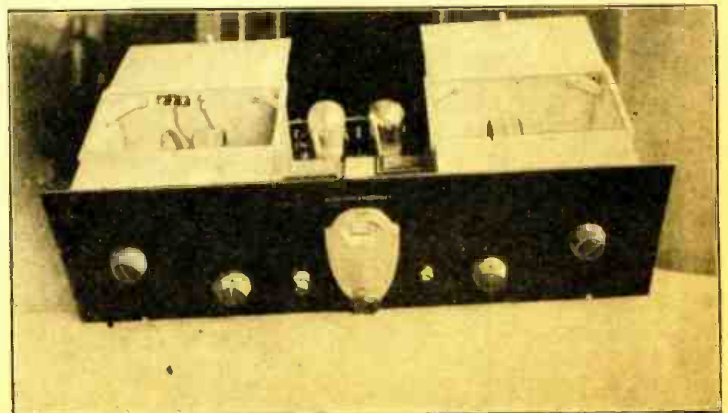

Fig. A

The problem of changing plug-in coils is greatly simplified in this manner.

The Cooperative Radio Laboratory

A discussion of some facts and some fallacies about push-pull amplification, and a direct-coupling push-pull system of the director's own design

By DAVID GRIMES

THE two preceding installments of the Cooperative Laboratory section (in the May and June issues of RADIO-CRAFT) have dealt with the "direct-coupled" amplifier—more properly "direct-resistance coupled"—at present so much in the public eye. They have brought out the fact that, hitherto, resistance coupling in its usual form, employing a coupling condenser, has given the best quality for the money.

The two principal obstacles to a more general acceptance of this circuit have been considered, and are here recapitulated. They are: first, the use of a resistance-coupling device in the plate circuit of a tube necessitates the application of a higher plate voltage, in order that the same actual potential may be impressed across the tube itself. Secondly, the grid of the last audio tube "chokes up" on the least little overload.

With the advent of the "B" socket-power unit, it became an easy matter to obtain the needed higher plate voltage; but the choking effect caused the idea of resistance coupling to remain much in the background. There seemed to be no way to escape this undesirable grid choking, other than the direct-resistance coupling system of amplification; which has forced its way to the fore for this very reason. This subject has been fully covered before; so, for further details you are referred to the two previous issues.

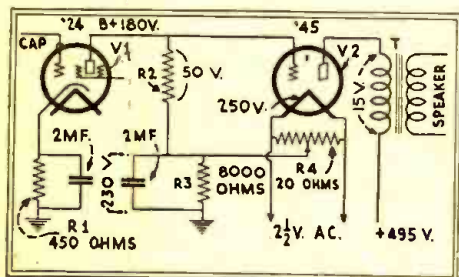
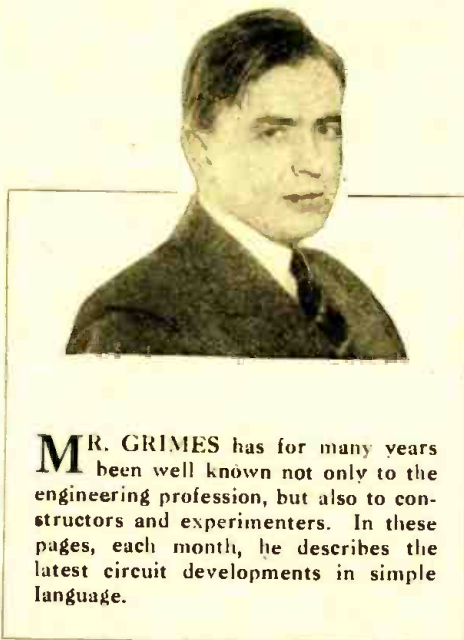

Fig. 1

Showing the enormous voltage demand of the direct-coupled amplifier, requiring special power supply.

The proposition which we wish to set forth is, that the present direct-coupling system has certain limitations which preclude its ready adoption by the general experimenter. One of these is in the fact that a special power pack is required for its proper operation; while many fans have been led to understand that the supreme quality obtained by the circuit arrangement is due primarily to the direct coupling, and not to the mere fact that it is resistance coupling. So the cost and trouble of the extra pack has been tolerated.

Now, realizing that the real quality of the contraption is the natural result of the resistance-coupling principle, and bearing in mind that the only limitation is grid choking in the last audio stage, it would



MR. GRIMES has for many years been well known not only to the engineering profession, but also to constructors and experimenters. In these pages, each month, he describes the latest circuit developments in simple language.

seen best to proceed along the proper scientific lines to overcome the grid choking limitation, so that the regular, standard resistance system could be adopted—thus utilizing the average power pack and escaping the extra expense.

Demands on Rectifier System

First, let us see just why the special power pack is required. Reference is here made to Fig. 1; if we start with the first tube V1, a '24 type, we will note that it should have a plate voltage of 180, according to the best tube practice. Then the grid bias for the power tube is obtained from the plate voltage drop across R2; which represents another fifty volts which has to be supplied to the low end of the plate circuit of V1. Since this plate supply comes entirely from R3, the cathode resistor in the power stage, it is necessary for the filament of the '45 to be so much above ground potential. Hence, the plate source for V2 must supply voltage equal to that needed for the '45, plus that across the cathode resistor supplying the plate circuit of the '24.

A little arithmetic reveals the rather startling fact that the "B" unit must have an output of about 500 volts—when we count the drop which always occurs across the output transformer T in the plate circuit of the power tube. Such a strain on the rectifying tube is severe; and the only reason for its somewhat peaceful operation is the low current which it is called upon to supply at that pressure. This very predicament eliminates it as a source of "B" current for the rest of the radio receiver; it must be, truly, an extra pack. The circuit details of Fig. 1 are self-explanatory;

There is no need to use space to point out the obvious circuit connections.

Since grid choking caused by excessive grid swing is the only stumbling-block in the way of using standard resistance coupling, and standard resistance coupling requires only the normal voltages for the tubes (since each tube obtains its plate voltage direct from the source of supply, without grabbing it from another part of circuit) it should be obvious that we must seek some circuit which eases the grid swing without sacrificing signal strength. Push-pull coupling suggests itself immediately.

Push-Pull Peculiarities

Since push-pull coupling is more or less familiar to you, we will merely point out the factor with which we are at present concerned. It will be noted that the secondary of T1 is cut in half (Fig. 2), and that the grid swing or signal is really divided into two equal parts. The center tap being grounded, the upper portion of the signal is applied to the grid of V2, while the lower half of the signal is applied to the grid of V3. The important thing to note is the *opposite polarities* of the two half-signals. At the instant under consideration, the signal is positive on the upper grid and negative on the lower grid; this is the prime requisite for push-pull amplification. Unless the two applied signals are of opposite polarity at any given instant, the system will not function.

But, if push-pull is the obvious answer, why has it not been incorporated, long before now, in the resistance-coupling circuit? Well, it is easy to see that the arrangement of Fig. 2 is a transformer circuit of a type in use for several years. But transformer circuits are not resistance-coupling combinations, and therefore are costly, if real tone quality is demanded. The real problem is to devise some push-pull arrangement for a resistance-coupled amplifier. This has proved to be the sticker.

Many, many ideas have been presented but most of them are erroneous in conception; to illustrate this, Fig. 3 is presented. The inventive novice starts in by tapping

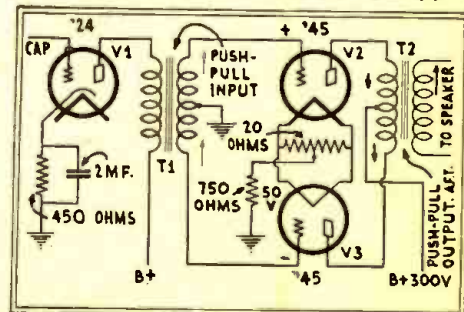

Fig. 2

The standard push-pull swing cuts in two the grid swing on each tube; note the opposite grid polarities.

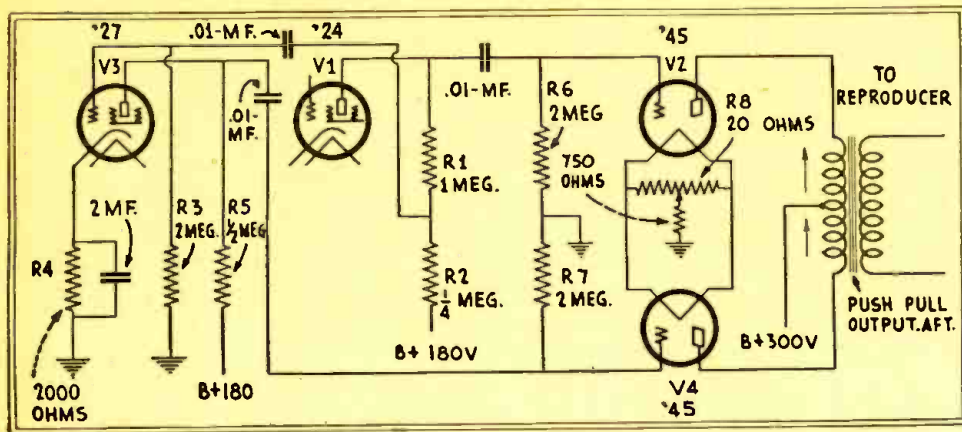

Fig. 4

The introduction of the phase-shifting tube V3 between the plate of V1 and the grid of V4 makes possible push-pull operation with resistance coupling. The problem is to balance the push-pull signals.

the plate coupling resistor R2, in a similar manner to the tap on the input winding of the push-pull transformer. A graver error could not possibly be made; he has forgotten that, at any given instant, the signal at the tap is in the same direction as the signal at the top of the resistor. If the grid of V2 is plus, then the grid of V3 will be plus—only the signal will be of reduced magnitude at the tap. The same signal polarity on the two push-pull grids will result in opposing currents, in the push-pull plate circuits; and these will practically wipe out the signal response in the speaker, if the two '45s have similar characteristics.

An Ingenious Device

No, it is necessary to secure some sort of "phase reversal"; so that the lower portion of the signal input, on V3, will be "out of phase" with the upper portion of the impressed signal on V2. The split primary on a transformer will do this, but a tapped resistor will not.

Fig. 4 is next furnished to aid in our development progress. It shows a very ingenious stunt which has attracted considerable attention in this country and abroad. Only recently we noticed an English publication, *Experimental Wireless and the Wireless Engineer*, had in 1929 extolled the possibilities of this "extra-tube" resistance-push-pull circuit. Keeping in mind the need for reversal of phase in the lower channel in the push-pull system, the use of the extra tube becomes rather apparent; it is employed only for this phase-shifting. The success of the arrangement depends on the simple principle of polarity turn-over, which occurs in a resistance-coupled tube. When the grid of V3 is positive (relatively positive by the impression of the incoming signal) the plate current increases, resulting in a drop of plate voltage at the top of the resistor R5. Such a change in the potential at this point is equivalent to a negative impression, which is then applied to the grid of V4. We thus have plus on the grid of the phase-changing tube V3 and minus on the grid of the subsequent tube V4 which, in this case, is made the lower channel of the push-pull tube circuit.

There is still another requirement for satisfactory push-pull operation—the signals on the two channels must be not only completely out of phase, but of practically equal potential for all frequencies. The extra tube thus introduces added difficulty while performing its duties as phase or polarity

shifter. There is no easy way to prevent the tube from amplifying, according to its wont; so, if we are not careful, the reversed signal will arrive at V4 with more "pep" than the upper-channel signal at V2, which has not been placed through an additional tube. (This is particularly likely to occur at one extreme or the other of the audio band.) The trouble is partially remedied by tapping off only a small portion of the

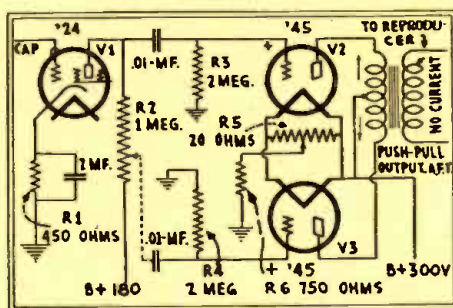

Fig. 3

A very ingenious method of obtaining push-pull resistance coupling; the trouble is, it doesn't work. Observe the opposing grid polarities.

output energy of the first tube V1, which feeds into the push-pull combination. The amount of tapping is adjusted to balance exactly the gain from the extra amplification. It should be clear, if the gain of the tube is about five (considering its normal "mu" as somewhat reduced by the high plate resistance and the consequent lowered plate

voltage), that the reduction of energy through the tap should be in the same proportion. This accounts for the tap being located four-fifths down on the plate resistor R1-R2.

Such a scheme as that of Fig. 4 has the disadvantage of introducing an extra tube, which adds little in the way of efficiency and much in the way of complications. For this reason it has never proved very popular among the engineering profession, though it has been known for some time.

Push-Pull Resistance Coupling

We therefore are bound to offer the suggestion outlined in Fig. 5. The '24 input tube operates in the regular fashion, and the departure lies wholly in the method of obtaining the equal, and 180° out-of-phase, potentials for the following push-pull tubes.

The simplest manner of following the circuit is to proceed with the upper channel, for this functions exactly like the standard resistance-coupled circuit. In this respect there is no difference. The one-half megohm resistor R1 acts as the plate coupling unit, while the four meg. resistor R3 in the screen circuit merely acts as the voltage reducer to allow the proper potential to reach the screen-grid. The by-passing 0.2-mf. condenser serves to keep the screen-grid at the cathode potential, so far as alternating currents are concerned. Even the 10,000-ohm resistor R4 in the immediate cathode circuit, by-passed by the 1.0-mf. capacity C1, is nothing unusual; since it furnishes the grid bias for the tube.

But from here on, the innovation starts! The cathode circuit of V2 does not then return to ground, but passes on through a resistor R2, with a value about twice as high as that of the plate resistor R1. The voltage drop across this unit furnishes the impressed signal for the lower push-pull channel. A short study will reveal the unusual result. As a relatively positive swing of the incoming signal is impressed on the grid of the '24 tube V2, the plate current increases according to Hoyle (or any other authority in whom you have confidence). As previously explained, this results in impressing a negative potential on the grid of the following push-pull tube V3. Simultaneously with this action, another is taking place because of this same increased plate current. The drop in potential across the lowest cathode resistor R2 has been in-

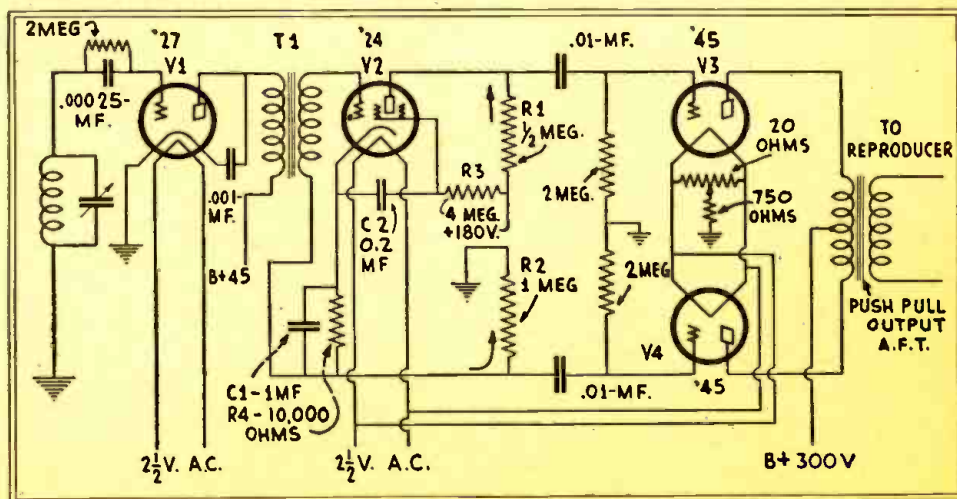

Fig. 5

The method illustrated above, devised and tested by Mr. Grimes, obtains direct push-pull resistance coupling. The reason for the different values of R1 and R2 is shown in Fig. 6.

creased, and such an increase effects a positive potential on its associated push-pull tube, V4. Hence, we have plus on the top channel and minus on the bottom channel, by one and the same change in plate current. Of course, the reverse action takes place in each circuit, when the impressed grid signal on the '24 tube V2 is reversed.

The additional requirement of equal voltage on both channels is governed entirely by the relative values of the plate and cathode coupling resistors R1 and R2 and, in this case, you will note the difference in the two values. The plate unit R1 is only one-half megohm, while the cathode coupling unit R2 is double this value. This was worked out first purely by experiment, and the values were chosen to give equal gain through the parallel paths. The reason for the apparent unbalance is not so obvious on the surface. It was some time before the true cause was unearthed.

Internal Tube Action

To go further into this particular ramification of the subject, the reader should refer to Fig. 6, where the cathode and heater of the '24 tube are shown on a little larger scale. Little thought has been expended on the action between heater and cathode in the heater-type tubes. Few circuits are concerned with this phenomenon; a fact which perhaps explains the dearth of information on the subject. Nevertheless, we are quite vitally concerned with this action. It seems that the heater acts in every respect like the filament of an ordinary tube, in that it is a prolific source of electrons. This is not serious except where the cathode is operated at a considerable positive potential (above ground); as in the case we are considering. Under the circumstances, the

cathode becomes a miniature plate, drawing electrons from the heater. The path between the two elements thus becomes a resistance, similar to that to which we are accustomed in the three-element tube. Then, if you study the layout carefully you will see that this resistive circuit is in parallel with the cathode coupling resistance—hence the need for making this value higher than the plate resistance. It so happens that the resistance of the heater leakage path just described is about one megohm—so the two parallel paths together constitute a total resistance of half this value, or about equal to that of the one-half megohm in the plate circuit.

And, by the way, the leakage path remains at that high one-meg. value only if the potential of the heater itself is around fifty volts, positive. For instance, if the heater of this tube should merely be grounded, so that the total voltage between the cathode and heater would be around 60 (the potential of the cathode, above ground), then the flow of electrons would be appreciable and this path would be almost a short

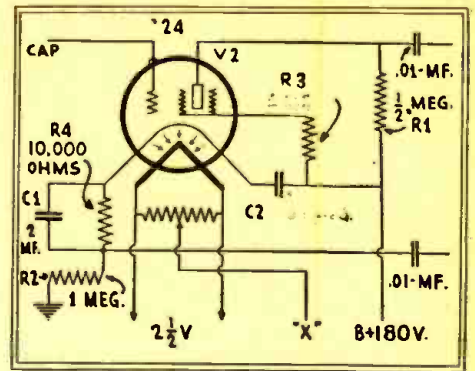

Fig. 6

Showing how a current between heater and cathode of a '24 tube introduces parallel conductance into the plate circuit.

circuit. No, the voltage of the heater to ground must be about equal to the voltage of the cathode to ground, to reduce or prevent this flow. The best practical solution lies in running the '24 heater off the same heater winding as the push-pull '45 tubes V3 and V4. You will recall that these filaments are run at a potential of fifty volts positive above ground, in order to provide the proper grid bias on these tubes. This gives us a very convenient source of a fifty-volt heater circuit.

It is not possible to run the '24 heater from an ungrounded or insulated winding—that is, to leave open the connection at "X" in Fig. 6. Hum is introduced by such an attempt. The push-pull scheme which we have outlined in this article is quite new and well worth some experimenting. Perhaps you will be the one to unearth some of its still hidden possibilities.

SO many entries, most of them accompanied by letters in long hand, have been received in the Prize Slogan Contest just ended, that it has been impossible for the Editor to read and pass upon all of them in the short time before the forms of this issue go to press, nearly a month before publication. The announcement of the winning entry, and of others meriting honorable mention, will be made in the August issue of RADIO-CRAFT.

Review of Recent Radio Literature

Publishers of radio books, and manufacturers issuing material of interest to the industry, the trade, the Service Man or the experimenter, are invited to submit them for review.

PRACTICAL RADIO CONSTRUCTION AND REPAIRING, by James A. Moyer and John F. Wostrel. (Second Edition.) Cloth, 5 by 7 1/2 inches; ix, 353 pages. Illustrated with diagrams and tables. Published by McGraw-Hill Book Co., New York City. Price, \$2.50.

This work is uniform in appearance with two others, *Practical Radio* and *Radio Receiving Tubes*, by the same well-known authors; and the three form a "radio construction library" for the constructor and the student, as well as a convenient reference set for the Service Man. All are of an exceedingly practical nature, and this work especially so. It was first issued three years ago, and the amplified edition described here is forthcoming in answer to an urgent demand for the extension of the scope of the work to cover the new principles of commercial receiver design.

Practical Radio Construction assumes an elementary knowledge of radio, such as that contained in its companion book, *Practical Radio*. It avoids theoretical considerations, as much as possible, and shuns formulas, going straight to the point. Beginning with the first necessity, the antenna installation, it reviews successively: tools and test equipment; sources of electricity for operation; amplifiers, both radio- and audio-frequency; receiver construction; resistance and impedance coupling methods; the building of sets of several types, including the superheterodyne and the short-wave receiver; loud-speaker construction; eliminators and chargers, and, finally, a 76-page chapter on trouble shooting brought up to the present styles in receivers. A few of the late sets are diagrammed; but the nature of the work is to educate the reader to understanding diagrams and circuits, rather than to compile them.

A systematic guide to set diagnosis, as well as a radio vocabulary, is included.

The style is clear, and the book may be commended for the practical constructor who wishes only that side of radio; while with its companions it provides a sound basis for the acquirement of a more thorough and scientific grasp of the whole subject. Since the vogue of short-wave broadcasting and reception is reviving the listener-constructor who studies his entire receiver as well as the dial, we may anticipate increased demand for works of this nature; as well as among serious students of servicing problems.

R. T. A. SERVICE MANUAL. Published by the Radio Training Association of America, Inc., Chicago, Ill. Introduction by Arthur G. Mohaupt. Flexible leather loose-leaf binder, 5 1/2 by 8 1/4 inches. 64 pages. 19 illustrations. Sheets printed on one side only. (Not sold.)

The facility with which a small, flexible loose-leaf booklet of this type can be carried in the pocket makes it especially useful to a busy Service Man. Its loose-leaf form enables it to be kept up-to-date, more and more complete as additional pages are published.

The first 26 pages cover general servicing information; the important phases of installing, servicing, and repairing commercial radio receivers are covered in a brief and concise manner. While no illustrations accompany this text, it is so written as to be easily understood by all who have a fair grounding in radio theory and practice. Special emphasis is made on the importance of ethical considerations to the Service Man, and many valuable hints are given as to personal appearance and con-

duct in dealing with the customer. For those who need it, these tips will no doubt be of value; although it may be queried whether a book on ethics will materially alter any reader's character.

Pages 27 to 50 inclusive were omitted from the copy which we have in our hands for review; but are to be furnished later.

The remaining part of the book, pages 51 to 88 inclusive, gives service data of commercial radio receivers; comprising, together with the diagrams, brief descriptions of the set, type of circuit, tubes, resistance values, and voltage values; in fact, all the usual information required by the Service Man for making a quick analysis of the particular set.

Data and schematic diagrams of the following sets are given, in the pages already issued: Philco Models 65, 76, 87 and 95; Majestic Models 71, 72, 91 and 92; Bosc Model 28, 48 and 49; Kennedy Models 10 and 20; Kolster Models K-43 and K-44; Atwater Kent Models 55 and 60; Amrad Model 81; Stromberg-Carlson Models 641 and 642; Edison Models R-4 and R-5; Victor Models R-32, R-52 and RE-45; Erla Model 224.

This manual, together with a set analyzer, is furnished only to students of the radio service course conducted by the publisher. (C. J. F.)

RESISTOR REPLACEMENT GUIDE.

Loose-leaf folder, containing 16 sheets of diagrams and tables, 8 3/4 by 10 3/4 inches.

Published and distributed free to service stations by the International Resistance Co., Philadelphia, Pa.

This is what a good many Service Men have been asking for; it is a compactly-arranged tabulation of the data about each resistor, in each of a great

(Continued on page 55)

INFORMATION BUREAU

SPECIAL NOTICE TO CORRESPONDENTS: Ask as many questions as you like, but please observe these rules:

Furnish sufficient information, and draw a careful diagram when needed, to explain your meaning; use only one side of the paper. List each question. Those questions which are found to represent the greatest general interest will be published here, to the extent that space permits. At least five weeks must elapse between the receipt of a question and the appearance of its answer here. Inquiries can be answered by mail only when accompanied by 25 cents (stamps) for each separate question. Other inquiries should be marked "For Publication," to avoid misunderstanding. Replies, magazines, etc., cannot be sent C. O. D.

"AERODYNE SIX"—TROUBLE SHOOTING

(69) Mr. A. B. Schoonover, Cuyahoga Falls, Ohio.

(Q.) I have an "Aerodyne Six" that I built two years ago. I could never get over 1200 miles with it; and now it is good for only about thirty-five. When the second R.F. tube is removed, the volume is increased, but not the distance; sometimes, removing the first R.F. tube has the same effect. What is wrong and how can I correct the fault? For your convenience, the diagram has been forwarded to you.

(A.) We believe the major cause of the trouble lies in the old-fashioned design of the receiver; the tubes used and climatic conditions may cause a considerable variation in the performance of the set. It may be presumed that the ganged stages have lost their alignment. Trimming condensers should be placed in shunt to the tuning condensers, as shown in dotted lines (Fig. Q69). These may be of the type adjusted by a screwdriver, or of the knob-control type suitable for mounting on the front panel. If the parts have been placed symmetrically, as regards the electric fields of the instruments, it will be convenient to use the former type of balancing condensers. Otherwise, the circuits will not tune exactly the same at all points in the tuning range; some will require re-balancing. In the latter case, the panel-controlled instruments are to be recommended.

If the individual stages are not sufficiently isolated, circuit oscillation may result before the maximum signal amplification possible has been obtained through the tube. The remedy here is to carefully check the possible feed-back conditions existing in the set. A successful means of mitigating the effect of feed-back coupling is the use of series grid resistors, each of 500 to 1000 ohms. They are placed between the tuned circuit and the grid of each tube, (V1, V2, V3) at the points marked X in the diagram. This will necessitate moving the potentiometer arm more toward the negative end; resulting in greater signal amplification and less "B" battery consumption.

Remove all fixed condensers and test them for leakage.

Improved tone quality and better control of detector sensitivity will result if the detector tube V4 is "parallel-plate-feed" connected to the first A.F. transformer, T1. (This change is shown in detail at lower left of complete diagram.) A .001-mf. condenser should be connected as shown at C10, and the capacity of C6 should be changed from .006-mf. to 2.0-mf.

Remove tubes V1 and V2, and tune in a powerful local station, using only V3, V4, V5 and V6. Now, try several tubes in the third R.F. position (V3), noting the setting for the trimming condenser in shunt with C3. Best results will be obtained (the circuits will be less likely to go out of balance at one extreme or the other of the tuning band) if a set of four tubes (for the three R.F. and detector) can be obtained which do not necessitate any change of the trimming condenser.

Details of the parts used in this kit set are as follows: L1, L2, L3, L4, Aero coil kit No. U-16; C1, Hammarlund, .0005-mf.; C2, C3, C4, Hammarlund, .0005-mf. (ganged); C5, Carter, .00025-mf.; C7, C8, Tobe, 1.0-mf.; R1, Yaxley potentiometer, 200 ohms; R2, Yaxley 6 ohm rheostat-switch; R3, Yaxley 1-ohm fixed resistor; R4, Tobe 2-meg. leak with Polymet mounting; T1, T2, Silver-Marshall No. 220 A.F. transformers. Except for a '12A power tube at V6, type '01A tubes are used. C9 (in the lower sketch) should be 0.25-mf., and R5 a variable resistor with 100,000-ohm maximum.

(Q.) After the power is turned on, it is necessary to jar a certain 1929-model Atwater Kent to start it playing; and the volume must be constantly controlled by hand. What is the cause and how can it be overcome?

(A.) The trouble is almost certainly due to a poor connection, either in one of the instruments or at a juncture. However, the trouble may be external to the set; check the condition of the aerial, lead-in, and ground. With a voltmeter, test the filament supply with a voltmeter to determine whether the source is a steady one. Make sure there is no break in the reproducer leads.

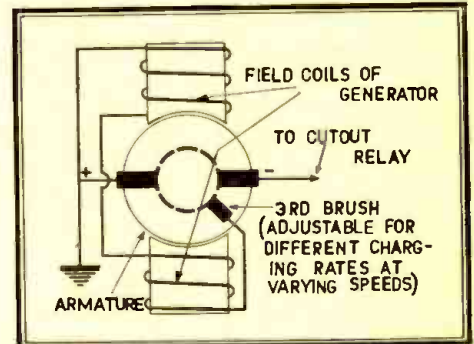

(Fig. Q70) Since the field coils of an automobile generator are excited by the battery, reversing the battery connections automatically reverses the polarity of the generator, so that the battery will be properly charged with either connection.

AUTOMOTIVE RADIO CONNECTIONS

(70) Mr. W. A. R. Miner, Mildred, Pa.

(Q.) In the article "Simplified Automotive Radio Installation," in last month's RADIO-CRAFT, Mr. Egert states: "If the 'A-' is grounded, the receiver is connected up as shown. If the 'A+' is grounded to the car frame, reverse the battery connections and make the car frame a negative ground, instead. This will change nothing except that it reverses the reading of the ammeter on the instrument board; accordingly, reverse the connections to the meter and everything will then be in proper shape." I beg to differ with him.

If he does not reverse the connections on the generator he will have the finest case of run-down auto battery he ever heard tell of. You see, when the positive terminal of the battery is connected to the frame, the positive side of the generator is also grounded; so that when the battery terminals are reversed those on the generator should also be reversed. I may also say that those of the generator are inside the generator case and, in most

(Continued on page 56)

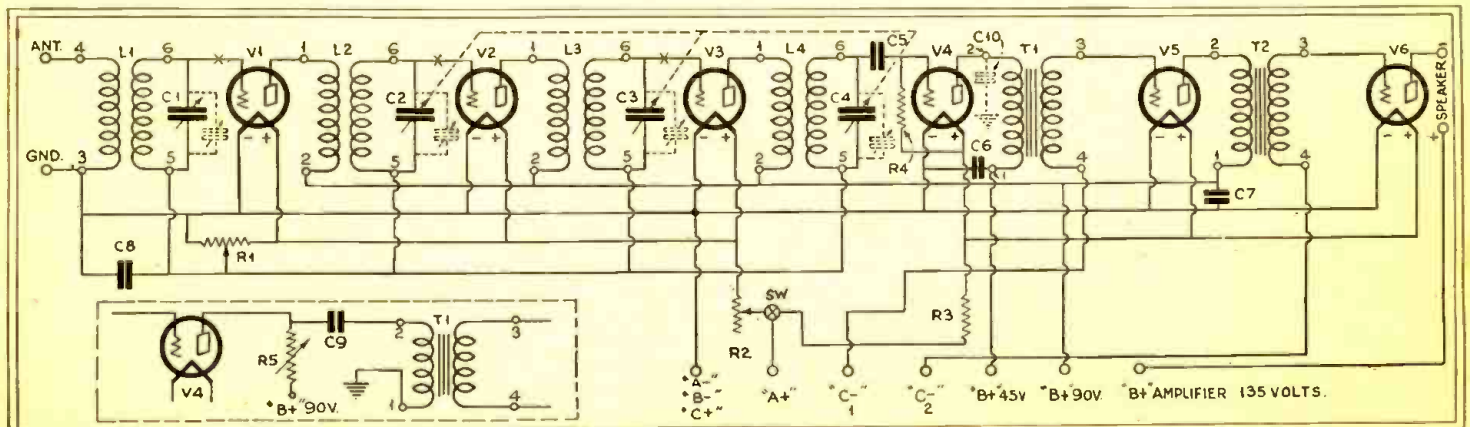

(Fig. Q69) The "Aerodyne Six" was in its day a very good receiver; with certain refinements introduced, it will serve those whose needs are satisfied by a battery-operated set. A few simple changes are shown by the dotted lines and Xs in the original circuit, above; and the recommended "parallel-plate feed" detector circuit is given at the lower left; the plate should be by-passed to ground by C10 in either case.

Let RCA INSTITUTES Start you on the road to SUCCESS in RADIO

RADIO needs you . . . That's why the entire Radio industry is calling for trained men . . . That's why thousands of men who answered these advertisements are now earning from \$2,000 and up a year. Manufacturers, broadcasting stations, aviation and radio are now eagerly seeking trained RCA Institutes men . . . Aviation and radio in the movies also provide innumerable opportunities . . . Millions of sets need servicing . . . thousands of ships require experienced operators . . . Never before was there an opportunity like this in Radio.

*This Is the Only Course Sponsored by
Radio Corporation of America*

The RCA Institutes' Home Laboratory Training Course enables you to learn Radio in your spare time. In only an hour or so a day, you can obtain a thorough, practical education in Radio . . . You study right at RCA, the world's largest Radio organization. You learn Radio by actual experience with the remarkable outlay of apparatus given to every student. That's why every graduate of RCA Institutes has the experience, the ability and the confidence to hold a worthwhile Radio job.

RCA Institutes offers four different courses . . . Here is the instruction that you need . . . A complete serviceman's and repairman's technical course . . . an advanced course . . . complete course without code . . . and a complete course including code. Practical instruction with each course. These are the courses that thoroughly teach construction, repairing, service, broadcasting and ship operating.

*Graduates of RCA Institutes Find It Easier
to Get Good Jobs*

SEND FOR THIS FREE BOOK . . . Read about these practical RCA methods of training that have prepared hundreds of men for success in Radio. Everything you want to know about the opportunities in Radio. Forty fascinating pages, packed with pictures and descriptions of the brilliant opportunities in this gigantic, world-wide profession. Remember that you, too, can be successful. The man who trains today will hold down the worthwhile Radio job of the future.

See for yourself why graduates of RCA Institutes now occupy thousands of well-paid positions. These positions are usually available in from 3 to 10 days after graduation for men who can qualify. RCA Institutes will back you up to the limit. Our catalogue is yours, free . . . SEND FOR IT TODAY!



*Radio Mechanic
and Inspector
\$1800 to \$4000
a Year*



*Land Station
Operator
\$1800 to \$4000
a Year*



*Broadcast
Station Mechanic
\$1800 to \$3600
a Year*



*Broadcast
Operator
\$1800 to \$4800
a Year*

**Clip this Coupon
NOW!**

**RCA
INSTITUTES, INC.**

A Division of Radio Corporation of America

RCA Institutes, Inc.
Dept. RC7, 75 Varick St., New York, N. Y.
Gentlemen: Please send me your FREE 40-page book which illustrates the opportunities in Radio and describes your home laboratory-method of instruction.

Name.....

Address.....

State.....

Occupation.....

Modernizing the Old Receivers

(Continued from page 10)

in many cases, it will be found desirable to reduce the plate voltages below the rating of the '26 tubes, to prevent oscillation.

It should be noted that the power chokes, of the usual 30-henry, 60-to-100 millihenry, rating, are shown here connected in the negative lead of the power unit. However, they may be connected in the positive lead, at the points marked X, with practically no change in performance; the latter connection is the more usual one. Both methods are used in commercial sets.

Taking Out "Bugs"

If there is any variation from normal operation when the conversion is completed, it is advisable to check the tubes, either by substitution or by test. Both methods, in fact, should be followed because, very often, tubes will give perfect readings when the ordinary test instruments are used, but do not function well in the receiver.

Special attention should be given to placing the power supply unit, when the job is ready for installation. If care is not taken to keep the pack at a sufficient distance from the converted set, inductive coupling between the two units may cause considerable hum. If the power transformer is not well-designed, hum may result, due to the electrical center being different from the mechanical center. A defective center-

tapped filament resistor, in which the electrical center is not the mechanical center or tap, will cause a certain amount of hum. For this reason it may be desirable to use center-tapped units in which the tap position is variable; there are several makes of these. The grid leak and detector, in the remodeled circuit, have been changed from the standard Atwater Kent connection (leak directly to filament) to the more conventional shunt circuit shown in the schematic diagram.

(A.C. tubes have a tendency to cause a greater degree of feedback than battery tubes of the same general characteristics and, for this reason, some other plan than reducing the "B" potential applied to the R.F. tubes may be advisable. For example, the values of R5 and R6 may be increased; either changing the resistor or adding a resistor in series with each one; the former is preferable as it keeps the grid leads short—*Editor.*)

The parts used, and values, to make the changes shown, are: one UY socket, for V4, one ABC transformer, with five secondaries of the voltages shown at PT; one condenser bank, with values as follows—C1, C2 3-mf.; C3-C4, 2-mf.; C5-C6-C7, 1-mf.: the first three should be able to stand a 600-volt D.C. test. The voltage divider R1 may be up to 20,000 ohms with movable bands, and should be able to carry 100 milliamperes. R2 is 400 ohms, R3 2,000 ohms; and R4 may be any suitable volume-control resistor. Ch1, Ch2, as used by the writer, is a dual choke in one housing. The center-tapped resistors

R7, R8 and R9 are 20 ohms each. R5 and R6, found in the original circuit, are 800 ohms. Any standard kit for a 71 power pack is usable. The entire cost, for parts of the best quality, should not run over fifteen dollars to the dealer or Service Man. The method described can be very easily applied to any of the popular five- or six-tube battery receivers.

(Further improvement in these Atwater Kent receivers along the lines of audio quality may be effected by replacing the audio transformers T1 and T2 with more modern units; it is recommended that the builder change, at least, T1. Particular makes are not named, for every radio man has his personal preferences. The primary of this transformer, also, should be bypassed to ground by .006-mf.—*Editor.*)

In a subsequent article, the necessary details of renovating another old-time favorite receiver will be explained.

Fidelity or Volume?

(Continued from page 21)

The magnetizing force of course now becomes zero; but because of the retentivity of the iron, the magnetic density is not zero, but has the value indicated by *ob*. Now let us turn on the current again. The magnetization returns again to the value it had before, but by a different path on the graph. It returns by the path *bda*; whereas before it dropped by the path *acb*. There is thus formed a minor loop which, of course, has

EVERY
SERVICE MAN
SHOULD OWN
THIS BOOK!



(1930 Definitions)
FULLY ILLUSTRATED
Size 9 x 12 in.
Over One Inch Thick
168 Pages
Written in Plain English

S. GERNSBACK'S RADIO ENCYCLOPEDIA

The First Real Radio Encyclopedia Ever Published

Regular Price **\$2.00** Our Special Price **\$1.49**

EDITED by SIDNEY GERNSBACK. Author of "Wireless Course in Twenty Lessons" — "One Thousand and One Formulas" — "Practical Electricity Course" — "The Radio Educator," etc.

S. GERNSBACK'S RADIO ENCYCLOPEDIA is the only standard work ever published in America attempting to classify alphabetically the countless words used in the highly specialized science of RADIO. The ENCYCLOPEDIA is written in plain English so that everybody can understand the definitions and descriptions.

No expense has been spared, covering over two years in compilation, to make it worthy a place in your library.

It is published in one volume—168 pages—size 9 x 12 inches, over an inch thick and nicely accommodates the beautiful illustrations and the large, easy-to-read type.

The work contains 549 photographs, drawings and diagrams.

REMEMBER THIS IS A REAL ENCYCLOPEDIA — NOT A DICTIONARY — and very few of the things described and illustrated in this volume can be found in any diction-

ary, or any other encyclopedia.

The book contains as a supplement a classified cross index designed to bring together radio references under one heading having relations in common.

All circuits new and old are described by word and picture and every part and apparatus used in Radio is explained and made understandable by means of photographs and drawings.

The volume is printed upon fine paper—bound in full black Keratol, marbled paper fly leaves and end sheets, with the title stamped in gold.

SEND NO MONEY

Just Pay Postman

(Canada or Foreign send Check or Money Order for \$1.75)

ISKOR PRESS, Inc., R-7-30
286 Fifth Avenue,
New York, N. Y.

Send me one copy of Sidney Gernsback's First Radio Encyclopedia in one volume as advertised. I will pay postman \$1.49 plus postage on delivery.

Address

Town and State.....

Name

no particular significance, (because we always operate with the switch on) but leads to ideas of what happens under operating conditions.

Why Inductance Decreases

The curve *acb* is part of the hysteresis loop, indicated by the broken line. Now let us turn the set on, and leave it on. We are operating at the point *a* of Fig. 7B, which is a tip of the hysteresis loop shown as a broken curve. Now let us tune in a signal which is, of course, alternating current. During half the cycle the signal current adds to the magnetization, and during the other half it subtracts. So a minor loop is formed with the point *a* at its center. According to our definition of inductance, and since we are only interested in the change of flux which the alternating component produces, the effective or apparent permeability is the slope of the line joining the tips of the minor loop; that is, the slope of the line *cd*. It is clear that this is much less than the slope of the major hysteresis loops. Furthermore, it varies with the size of the minor loop and its location on the major loop. The effective inductance varies proportionally with the effective permeability. The further the minor loop is from the origin *o*, the less is its slope; the greater the minor loop, the greater is its slope.

So, the greater the D.C. component in the transformer, the less is the effective inductance for a given signal strength. Also, the greater the signal strength for a given value of D.C. component, the greater will be the effective inductance. Of course, we are assuming that the operating point is not too near the condition of saturation.

The curves of Figs. 6, 8 and 9 show these effects as measured experimentally on a commercial transformer. In Figure 6 the inductance is seen to increase with the alternating signal current, as also in Fig. 8 with the alternating signal voltage applied to the transformer terminals. Also, the greater the direct-current component in the winding, the lower is the inductance curve. The effect of the D.C. component on the inductance is shown very clearly by the curves of Figure 9. The lower curves of Figs. 6 and 8 becomes flattened as the signal component is increased; because the D.C. component is so great that saturation is being approached.

Effect of Strong Signals

It is interesting to note what happens in a transformer which is connected in the plate circuit of the "C" bias detector. As the signal strength applied to the grid of the detector increases, it is well known, the constant current in the plate circuit of the detector increases; so that we should expect the effective inductance of the transformer to decrease. On the other hand the increased alternating (signal) component tends to uphold the effective inductance; so that we should expect the inductance of the transformer connected to the detector to remain substantially unchanged. What actually happens is shown by the broken curves of Figs. 8 and 9. The tendency of the inductance to remain unchanged is clearly indicated; actually the change is not great, being hardly more than ten per cent.

Fortunately, the changes of inductance due to changes of signal strength are not great, but they must be borne in mind when designing transformers and chokes; and due provision must be made to avoid saturation,

PATENTS INVENTORS

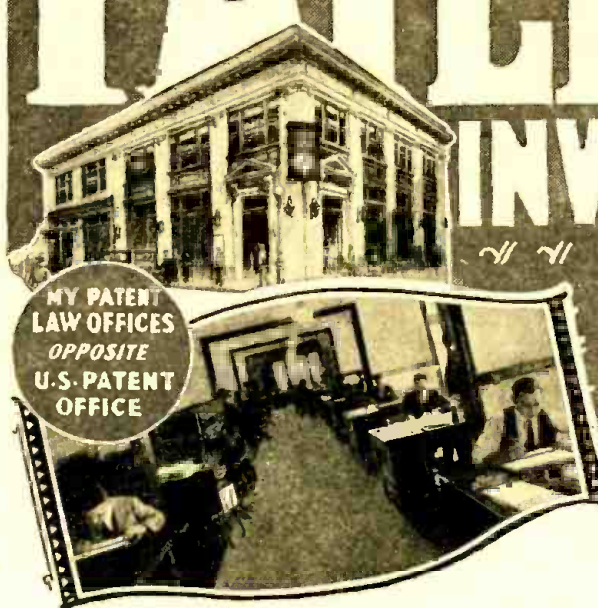

**Write for these
FREE BOOKS!**

At the left is a view of my drafting and specification offices where a large staff of experienced experts is in my constant employ. All drawings and specifications are prepared in my offices.

Protect Your Ideas Take the First Step Today

If you have a useful, practical, novel idea for any new article or for an improvement on an old one, you should communicate with a competent Registered Patent Attorney AT ONCE. Every year thousands of applications for patents are filed in the U. S. Patent Office. Frequently two or more applications are made for the same or substantially the same idea (even though the inventors may live in different sections of the country and be entirely unknown to one another). In such a case, the burden of proof rests upon the last application filed. Delays of even a few days in filing the application sometimes mean the loss of a patent. So lose no time. Get in touch with me at once by mailing the coupon below.

Prompt, Careful, Efficient Service

This large, experienced organization devotes its entire time and attention to patent and trademark cases. Our offices are directly across the street from the U. S. Patent Office. We understand the technicalities of patent law. We know the rules and requirements of the Patent Office. We can proceed in the quickest, safest and best ways in preparing an application for a patent covering your idea. Our success has been built on the strength of careful, efficient, satisfactory service to inventors and trademark owners located in every state in the Union.

Strict Secrecy Preserved— Write Me in Confidence

All communications, sketches, drawings, etc., are held in strictest confidence in strong, steel, fire-proof files, which are accessible only to authorized members of my staff. Feel free to write me fully and frankly. It is probable that I can help you. Highest references. But FIRST—clip the coupon and get my free book. Do THAT right now.

No Charges for Information on How to Proceed

The booklet shown here contains valuable information relating to patent procedure that every inventor should have. And with it I will also send you my "Record of Invention" form, on which you can sketch your idea and establish its date before a witness. Such evidence may later prove valuable to you. Simply mail the coupon and I will send you the booklet and the "Record of Invention" form, together with detailed information on how to proceed and the costs involved. Do this NOW. No need to lose a minute's time. The coupon will bring you complete information entirely without charge or obligation.

Clarence A. O'Brien
Registered Patent Attorney

Member of Bar of Supreme Court of the United States; Court of Appeals, District of Columbia; Supreme Court, District of Columbia; United States Court of Claims.
Practice confined exclusively to Patents, Trademarks, and Copyrights



CLARENCE A. O'BRIEN

Registered Patent Attorney

3504 Security Savings and Comm'l Bank Bldg.,
Washington, D. C.

— or —

Suite 1106, Woolworth Bldg., New York City

Please send me your free book, "How to Obtain a Patent," and your "Record of Invention" form without any cost or obligation on my part.

Name

Address

(Important: Print or Write name clearly
and address office nearest you)

10 Tools in One

A SMALL but handy article which serves for every possible need of the all-round mechanic. Invaluable in any emergency.

An excellent combination of utilities for the household—every necessity featured: HAMMER — KNIFE SHARPENER — NAIL-PULLER — BOTTLE-OPENER — SCREW-DRIVER — CORK-SCREW — CAN-OPENER — WEIGH-SCALE — RULER — TABLE OF WEIGHTS AND MEASURES

Just glance at the illustration and you will see how really useful this article is. The "Ten in One Tool" is 10 inches high and finely nickel-plated.

The new tool is not only handy in the household, but every TOURIST, AUTO-IST, CAMPER, PICKNICKER, BOY-SCOUT, FISHERMAN, CANOEIST, etc., should carry in his bag one of these indispensable combination tools. No SHOP, OFFICE, STORE, GARAGE, FARM, BOAT, should be without one. PRICE \$1.00, POSTAGE PAID.

Be the first one to own the "Ten Tools in One" in your own town.

Send your order today, pin a dollar bill to coupon below and the shipment will go forward to you the same day order is received.

GREN PARK COMPANY
245 Greenwich Street
New York, N. Y.

Grenpark Company, 245 Greenwich Street, New York, N. Y. FG-7

Enclosed find \$1.00 for which please send me prepaid your "Ten Tools in One."

Name

Address

Town..... State.....

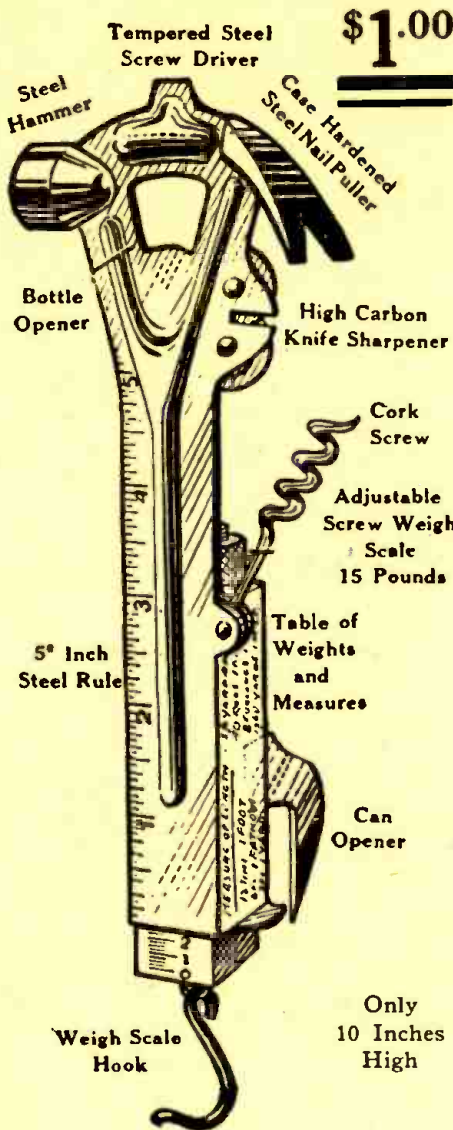

Only 10 Inches High

Mail Coupon
Send for Yours
TO-DAY

which would cause more trouble, by lowering the inductance, than the advantage of keeping the inductance at a constant value. For, as indicated by the curves, large D.C. components tend to keep the effective inductance constant for large signal components; but the general level of the curve has been greatly reduced, especially for small signal components.

Variations of inductance in transformers and chokes may be interpreted in terms of fidelity of reproduction as mentioned before. The greater the inductance (or impedance) the better will be the response to lower audio frequencies. In voltage amplifiers, the gain will be increased as the inductance is increased; while, in power amplifiers, the inductance may be varied considerably without producing any material change in gain.

Operating Notes

(Continued from page 16)

hum has been traced to a bad section of the Mershon condenser; while "fading" which was blamed on bad screen-grid tubes has been found due to cold-solder connections to the tuning condensers.

Feed-back and "peanut whistles" in "Kolster K" models are often cured by reversing the primary connections of the first audio transformer. Other cases require shielding the power tube—not the detector tube. In the console sets, the speaker cord will cause feed-back when too near the detector.

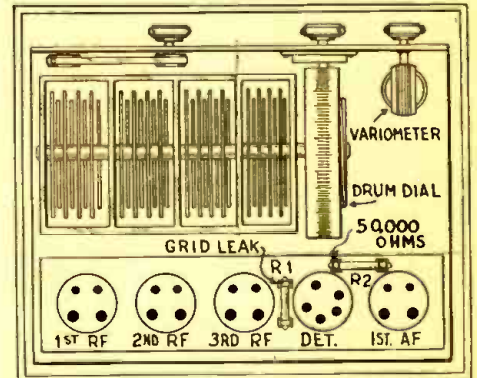

Fig. 7

Changing the value of R2 will change the tone of a Bosch "28" or "29".

Leaves from Service Men's Notebooks

(Continued from page 12)

the antenna resistor, which was not making perfect contact because of a rough and worn resistance strip. Luckily, I had a similar one with me.

With the new resistor in place, I temporarily hooked up the set out of the cabinet to see how it worked; it was perfect. In my triumph, I called the owner and asked him to try it. To my amazement, he said that the volume control was better now but that there was something unusual about the set; and he suddenly decided that I had changed the tone of it. Since he knew nothing about radio, I couldn't explain that replacing the antenna resistor would not change the tone, and I was about stuck. The set was a table model, and the speaker was at the end of the room; so that the removal of the chassis did not alter the acoustic conditions. I checked my work over and over and found nothing wrong. As it was late, I put the set back into the

HOTEL EMBASSY
BROADWAY AT 70TH ST.
NEW YORK

400 LARGE LIGHT ROOMS
ALL WITH BATH

\$2.50 A DAY FOR ONE PERSON
\$3.50 A DAY AND UP FOR TWO

Special Rates for Permanent Guests

FINE RESTAURANT
REASONABLE PRICES
Club Breakfast, 30¢ to 50¢
Luncheon, 75¢
Table d'Hote Dinner, \$1.00

EDMUND P. MOLONY
Manager

Orders - Inquiries

60 pages
Send for FREE Copy
Can be Secured by MAIL

POLK'S REFERENCE BOOK and Mailing List Catalog

Gives counts and prices on over 8,000 different lines of business. No matter what your business, in this book you will find the number of your prospective customers listed. Valuable information showing how to use the mails to secure orders and inquiries for your products or services is given.

Write for FREE Copy
R. L. POLK & CO., Detroit, Mich.
Largest City Directory Publishers in the World. Branches in Principal Cities
Mailing List Compilers—Business Statistics Producers of Direct Mail Advertising

cabinet and hooked it up, expecting to tackle it the next day.

But, before I packed up, I asked the owner to try it again and see if he could find the exact difference. Suddenly a smile beamed on his face; and he turned to me and said that it was perfect. I could hardly talk; and almost forgot my service fee, and quite forgot my customary good-night.

On my way home I came to this conclusion: In radio reception, the front of the receiver takes the place of the expression

of the face which is talking to you. What I had forgotten was to give the vibrations a face. With that restored, the set lost its strangeness to the eye of the owner, and once more became a friend of the family.

The moral is: a set may look like a million dollars in a cabinet; but out of the cabinet it is, to a person ignorant of radio, merely a piece of junk. When you finish your repairs, make a short test and then put the chassis back in the cabinet before letting the owner try it.

The Service Man's Open Forum

(Continued from page 17)

"know it all." I will never make that mistake; I had my lesson four years ago, and I am still studying.

Don't misunderstand me; I am not sore, and I do not feel that the poor old manufacturers should supply every Tom, Dick and Harry with information; for that hurts the manufacturer, the dealer, and the Service Man who has a real shop. But I do think that the manufacturer should get out of his head the idea that every dealer is or has a good Service Man.

Not long ago the chief Service Man of the Simmons Hardware Co., which is the Philadelphia distributor of the Apex, came to our shop and gave my boss (a young fellow like myself) a contract to take care of every Apex in this territory south of Camden, at a flat rate. (We do only dealers' work and that for the distributors, and do not advertise to the public.) Now, if I do say it, Apex dealers here get service. If other manufacturers and distributors looked around their territories, they could find real Service Men equipped to do up-to-the-minute work. I hope the manufacturers will give up the idea that anyone is an A1 Service Man, and give the independent Service Men a chance to show them something.

JAMES COYLE,

Unsworth Radio Laboratory,
Vineland, New Jersey.

A SET FOR THE CAR

Editor, RADIO-CRAFT:

I have been experimenting with automotive radio for the past seven months, and I think it is the best thing ever started, for pleasure in a car. With a volume control on my set, which can be turned from a whisper to enough volume to hurt your ears, I cannot see why it should be called unsafe to drive with the radio turned on. Several people have driven my car, two of them women, and they say it does not interfere with their watching the road—any more than listening to the radio interferes with one's playing cards. I think automotive radio is here to stay; and I am for more of it, since I am in the sales and service department, and think it will be a very profitable business.

I have tested several factory-built models in different cars, and for the past three months have used a special receiver, developed in my own laboratory, for a Ford "Model A" sport coupe. It is installed in the compartment behind the seat, on the right-hand side of the car, with the tuning dial, volume control and switch toward the

driver. It can also be tuned from the rumble seat.

It uses three '24s (one the detector) with filaments wired in series, and a resistance-coupled amplifier with two '01As and a '71A, working into a magnetic cone which is mounted in the side of the top, behind the receiver. The current drain is 2¾ amperes from the storage battery, and 26 mills from the "B" battery. The dry cells (135 volts "B" and 22½ volts "C") are carried in a metal box in the rumble seat, and the cable is shielded. The chassis is built on a steel frame, 12x8x8 inches; and completely shielded. A square yard of copper screen, tacked into the top of the car, serves for the aerial. With proper chokes and by-pass condensers and this resistance coupling, I find that about 60% of the ignition noise is eliminated. With one 25,000-ohm, 5-watt carbon resistor in series with the high-tension lead of the distributor, and a 2-mf. condenser across the generator, noise can hardly ever be heard, even as high as 1,500 kilocycles.

FLOYD A. ZEMMER,

Chief of Radio Dept., Keithley Bros.,
Michigan City, Indiana.

SERVICE MEN SHOULD STUDY

Editor, RADIO-CRAFT:

I specialize in electric power contracting; however, for the past six years I have sold and serviced radios of all descriptions, and I feel that I can understand both sides of the service situation.

First, the manufacturer has no reason to be enthusiastic about the average independent Service Man; who has usually, in the past, sold custom-built radio and been prone to knock most any factory job. Secondly, a competent Service Man with the proper testing equipment should not be compelled to write to the factory for prints.

Now, as to the Service Man. He should first be a licensed electrician. Proof of this is the electrical fire hazard report for 1928 (as given in *The Electrical Contractor*), which assigns radio as the third cause of fires in New York City; and estimates the damage caused, mostly by improper installation, at about eighteen million dollars.

I believe that investigation would prove that the man who bewails the small pay is of the type who knows that "E divided by I equals R," and thinks that he understands everything electrical. Again, he may be the graduate of a three- or six-month course, and believes that he should get the salary usually advertised by the school. A little

Successful Servicing Demands Good Instruments

» » »



Pattern 199 Set Analyzer

YOU can't afford to waste your time and endanger your success with inferior testing equipment when Jewell Pattern 199 Set Analyzers cost so little.

Here is the most popular set analyzer on the market—endorsed by leading radio manufacturers and engineers—the choice of the largest service organizations—proven by years of successful service—Jewell Pattern 199 is the logical choice of every alert radio service man.

The two large, easy-to-read meters are the best that can be made in this size. The selective type push button switches afford unequalled speed and convenience in testing.

The Pattern 199 is so simple to operate that service men of even limited experience can accurately and rapidly analyze set troubles when it is used in connection with Jewell Set Analysis Charts and a Jewell Instruction and Data Book.

It is false economy to handicap yourself with inferior testing equipment. You owe to yourself the advantages provided by Jewell Pattern 199. Mail the coupon for a 16-page bulletin that tells the complete story.

Jewell Electrical Instrument Company
1642-K Walnut Street, Chicago, Illinois

Mail your bulletin describing the Jewell Pattern 199 and other radio service instruments.

Name _____

Address _____

ALLERTON HOUSES

NEW YORK CITY, N. Y.

SO located they offer the social value of a distinctive address with the air and service of the select club; lounge, library, billiards, squash courts and hand-ball courts.

\$15 to \$25 Weekly

38th St., corner Madison Ave.
39th St., near Lexington Ave.
55th St., corner Madison Ave.

57th St., cor. Lexington Ave.
for women only

Chicago Cleveland
Allerton Houses, for Men and Women

Prepare for BIG PAY Jobs! Learn Radio and Television

Organized Labor—owner of Station WCFL, Chicago, the first station to broadcast television on an aural wavelength—is conducting a nation-wide good-will campaign and suggests the study of Radio and Television as a happy and profitable way of getting better acquainted, and makes this astounding offer:

Complete Radio and Television Course **ALL FOR**
Handy Loose-leaf Lesson Folder **\$2**
Radio and Television Dictionary **ONLY**
Large Schematic of Federation Four
WCFL Radio Magazine for One Year

You Assume No Moral Obligation in Accepting This Offer. It is a Good-will Project. The WCFL Radio and Television Course is used as standard text in more than four hundred high schools and is also being studied by nearly 50,000 adult students. It has helped thousands to increase their earnings.

OPENS THE DOOR OF GREATER OPPORTUNITY IN RADIO FIELD.

WCFL, 623 So. Wabash Ave., Chicago.

For the attached \$2 enroll me for the WCFL Radio and Television Course, also send me Loose-leaf Lesson Binder, Radio and Television Dictionary, Large Schematic of Federation Four and WCFL Radio Magazine for one year.

Name
Street
Postoffice State

Fighting for the Freedom of the Air
WCFL Radio Magazine is the only publication fighting for the freedom of the air—the gravest question now before the public. Whoever monopolizes broadcasting will control the Nation. The air MUST remain FREE.

A interesting announcement of the OFFICIAL RADIO SERVICE MANUAL is to be found on page 6 of this issue.

This Manual has been especially prepared for the Radio Service Man. It is a complete directory of commercial wiring diagrams of receivers.

A special pre-publication offer has been made—be sure to read it.

reasoning would show that, if radio and electrical engineers could be made in six months, it would not be necessary to pay high salaries to them.

If you are the man who thinks you are not getting enough and should be advanced to the high-salaried class, be honest and ask yourself: "Do I know my algebra, geometry, trigonometry; can I work problems in calculus?" If you cannot answer yes, then perhaps you are getting just about the amount for which your employer can get another man or boy of equal ability.

W. J. SAUNDERS,
Merom, Indiana.

Whose Patent?

(Continued from page 15)

ployee, is required to forego legal protection on the processes, discoveries, or apparatus, which he devises or makes during the course of his employment at the bureau; either by reason of any alleged administrative policy of the bureau or by reason of any supposed implicit duty which an employee owes to his employer with respect to the service in which he is engaged, or by any necessity of dedicating the patent to the public.

On the contrary, the court held, every commercially useful improvement devised by a bureau employee during the course and as a result of his employment on government time and money, using government tools, equipment, and facilities, is the rightful legal property of the employee (provided he patents it) and not the property of the public.

Mr. Dunmore was alive to the facts. He took out three patents for improvement in radio receiving sets which, it has not been denied, he made in the capacity of employee, as a part of the day's work, and at the direction and expense of the Bureau of Standards in the role of employer. The results of his work were duly published in the Bureau of Standards Bulletin No. 450, read with approval and (as usual) appropriated by a commercial firm for profit.

Mr. Dunmore saw no reason why part of the profits were not his. No doubt he was ridiculed for his "unprofessional" attitude. However, he may have been irked by high standards and low pay; for he brought suit, won a fortune figuring in millions, and obtained a decision which merits the attention of every scientific man.

Mr. Dunmore is entitled to respect. He has shown the way whereby every employee, every scientific and technical man may secure a fair return for his effort and ability. Patent protection has been provided for the express purpose of securing compensation to the man who promotes technical science and the useful arts. It merely remains for him to avail himself of the opportunity.

(However, as a great jurist observed, "the law is the last guess of the last judge." Since Mr. Byers' article was put in type, a news dispatch informs us that the government has reopened the case by suing in the supreme court of the District of Columbia and the federal court for the Eastern district of New York, to obtain a conveyance of the Dunmore patents, held valid in a recent suit against the R. C. A. It is also forecast that legislation by Congress will be urged, to clarify the law.—EDITOR.)

Why Is Code Used?

(Continued from page 26)

favor of the radio telegraph; except where lay operation is indispensable, as in radio broadcasting. Obviously, an entertainment program cannot be sent by code.

True, notable progress has been made in radio telephony, quite aside from its best-known use, for broadcasting. Compact radio telephones are now employed aboard aircraft. Radio-telephone communication is being employed between ship and shore. The facsimile system is being constantly improved, eventually to be employed in handling radio messages direct in facsimile form. Nevertheless, these methods are more intricate, costly, and less positive for long-distance communication. It should be noted that the telephone was introduced many years ago by railroads for train dispatching and traffic orders; nevertheless, the telegraph has continued in use for such purposes.

For one interested in a radio career, the code is essential and will continue so for years to come, if not forever. Irrespective of what branch a man may be aiming for, the code will be found useful if not invaluable. Since no one can operate any form of radio transmitter, even facsimile and radio-telephone transmitters, without an operator's license (which calls for the mastery of the code) a radio man is indeed handicapped without code experience.

Most laymen fear even the mention of code, and yet the code may be readily mastered; the average man can learn it within six or eight months. There are many instances of boys mastering the code in three or four months, provided they follow a scientific method of instruction rather than the crude procedure of listening in on amateur and commercial traffic from the start. During fifteen years or more of training tens of thousands of men and boys for radio careers, radio instructors have developed ingenious shortcuts whereby the code may be mastered in a simple and rapid manner.

Spreading Stations on the Dial

(Continued from page 29)

Without completely rebuilding a set, it would seem, it is possible to use both coils to cover wide bands, as before, and coils to cover the specialized broadcast bands, as described. We may introduce a shorting switch around C4, so that it may be cut out, when desired; this method was much in use in the old days. Or we may wind our special coils on forms upon which are mounted small fixed or, preferably, semi-adjustable condensers, such that they may be set to optimum values for the broadcast band desired. (A five-prong socket would be required for this purpose, as in Fig. 3, unless a clip connector were used instead. In the case of a screen-grid first stage of R.F. amplification, before the detector, the familiar control-grid connector would be attached to C4 instead of C1.)

The following tables show the extent to which a series capacity spreads the readings of a tuning condenser from the middle to

POLYMET PRODUCTS

The HEART of Things Electrical

Strong Hearts win the industrial race, too! As compared with the ways of nature, electrical manufacturers have a tremendous advantage: they can determine heart-strength in advance! They can incorporate units, at the birth of equipment, which insure long life, stamina, leadership!

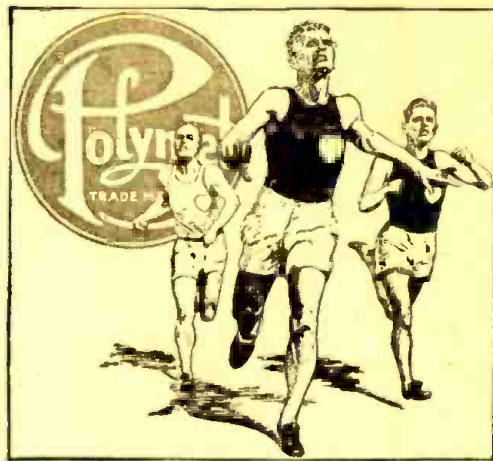

Polymet produces tested essential parts for many successful radio receivers, motors, ignition devices, clocks, telegraph and signal systems—where electricity actuates or controls. Such wide acceptance proves these carefully made Polymet Products are Strong Hearts, too!

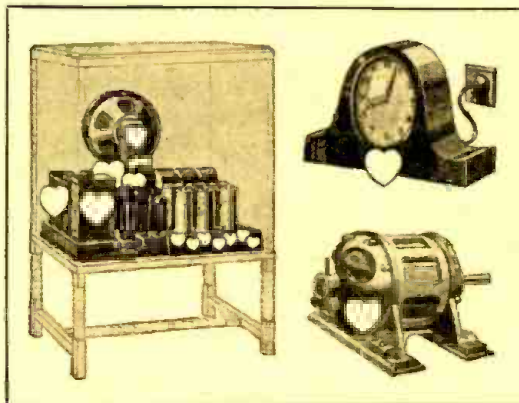

PAPER, MICA, AND ELECTROLYTIC
CONDENSERS,
ELECTRICAL COIL WINDINGS
TRANSFORMERS
ENAMELED COPPER WIRE, RESISTORS,
RADIO ESSENTIALS

Illustrated catalog of Polymet Products is available on request

Polymet Manufacturing Corporation
831-A E. 134th St. New York City

BE A RADIO DOCTOR



Radio servicing offers the biggest opportunity for the man interested in radio. About 10,000,000 receivers need service some time or other, many are naturally inefficient and can be improved on.

The Radio Doctors, Inc., is the only institution teaching exclusively radio repairs, having specialized on this phase of radio for a number of years.

\$3,000 to \$5,000 per year

The professional "Radio Doctor" receives \$2.00 or \$3.00 per visit and is welcomed in the best of homes—may I tell you more about this new, fascinating and extremely profitable business? Write now for free booklet, "Why the Radio Doctor." (Early inquiries will receive a blueprint of a recent well-known manufactured superheterodyne.)

E. W. PARKER, Pres. RADIO DOCTORS, INC., Dept. C12, 131 Essex Street, Salem, Mass.



SOMETHING DIFFERENT
No Flint. No Friction.
MAKE UP TO

\$40 A DAY

Showing My Mystery Lighter to Men. What Makes It Light? All Guaranteed. No Flint or Friction. New Principle of Ignition. Sample with Sales Plan. 25¢. Sample Gold or Silver Plated. \$1.00. Agents write for proposition. NEW METHOD MFG. CO., Desk SF-7, New Method Bldg., Bradford, Pa.

Write for Information about the NEW
H-F-L MASTERTONE
LABORATORY MADE RECEIVER
The Year's Outstanding
Radio Achievement
HIGH FREQUENCY LABORATORIES
28 N. Sheldon St. Dept. 78 Chicago, Ill.

Resistance PERFORMANCE that PAYS

ELECTRAD Resistances and Voltage Controls are built to highest standards. They serve—and serve well. That is why experienced service men prefer them for all replacement purposes.

Write Dept. RC7 for Complete Literature on all Electrad Products

175 Varick St. New York, N.Y.

ELECTRAD

Here at last -

is the one and only REAL big magazine on short waves you have wished for so long. Chock full with short-wave dope for the "ham," the amateur, the experimenter, the professional.

Over 250 illustrations, hook-ups, charts, circuit-diagrams and actual photos of receivers, transmitters and practical stuff.

Filled to the brim with honest-to-goodness "meat"—not a picture book, no mathematics, no theories that are over your head—PRACTICAL dope, live meat—that's what you want—and get.

On All
Large
Newsstands

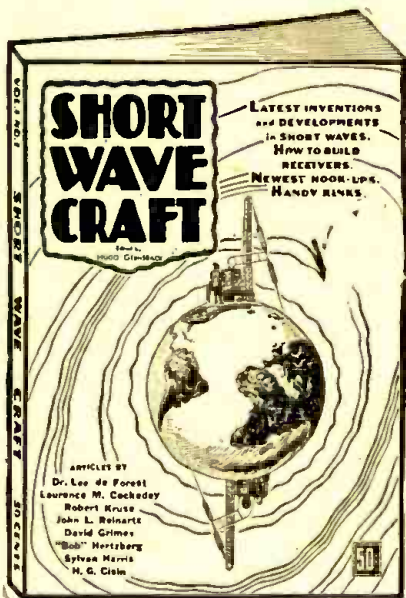

100 big pages, 9 by 12 inches, printed on a heavy grade of book paper, with a beautiful cover in four colors—that's SHORT WAVE CRAFT.

50c
The Copy

Contains more material than a \$2.50 book, yet the price is but 50c. a copy.

PUBLISHED ON THE 15th OF EVERY OTHER MONTH

Edited by Hugo Gernsback, originator of the world's best radio magazines, such as MODERN ELECTRICS, RADIO NEWS, RADIO-CRAFT, etc.

Mr. Gernsback has marshalled together the greatest short-wave experts, and they will write right along for SHORT WAVE CRAFT

Not only that, but he has imported articles by German and French short-wave authorities. Most of this material has never appeared in print in America.

Just glance at the contents of the first issue and be convinced.

Laurence M. Cockaday Robert Kruse "Bob" Hertzberg Sylvan Harris
Dr. Lee de Forest John L. Reinartz David Grimes H. G. Cisin

A Few of the Many Other Articles:

- Hertzian and Infra-red as a Means of Communication, by Dr. Fritz Schröter (translated from the German)
- Ten Centimeter Waves, by Dr. Ernst Gerhard (from the German)
- A Treatise on Short Waves, by Dr. Bley (from the German)
- Bringing Old Short Wave Receivers Up to Date, by "Bob" Hertzberg
- Importance of Smooth Regeneration and How to Obtain It in the Short Wave Receiver
- Short Wave Receivers—Simple as Well as Elaborate Receiving Sets
- Short Wave Transmitters—How to Build Them for Various Wave Lengths
- Short Wave Converters for Broadcast Receiving Sets

Regular Departments in SHORT WAVE CRAFT

- Photographic Section—pictures of latest short wave sets and stations
- Transmitters for Short Waves—How to build them
- Short Wave Receivers—Construction data for all types and kinds
- The Short Wave Experimenter
- The Short Wave Beginner
- Television on Short Waves
- Short Waves for the Broadcast Listener
- Ultra Short Waves
- Aircraft Short Wave Sets
- How to Build Short Wave Aerials
- How to Tell the Time in Various Parts of the World
- Short Wave Question Box

SPECIAL OFFER!

During the month of JULY ONLY, we are accepting Charter Subscriptions at a specially reduced rate of 40%. This offer is void after July 30th. Take advantage of this money-saving opportunity and fill out the coupon.

the top of the scale, while shortening its capacity variation from 60 to 75 per cent. at the upper end. (It must be remembered that the wavelength varies as the square root of the capacity in a circuit, if the inductance remains fixed; consequently the reduction in the tuning range would be only, say, 40 per cent., at the upper end.)

With .00005-mf. (50 mmf.) at C4	
Capacity of C1	Capacity of Combination
10 mmf. (minimum)	8.3 mmf.
25 "	16.6 "
37 "	21.3 "
50 "	25.0 "
62 "	27.7 "
75 "	30.0 "
90 "	32.1 "
102 "	33.6 "
115 "	34.8 "
128 "	36.0 "
140 "	36.8 "

With .0002-mf. (200 mmf.) at C5	
Capacity of C2	Capacity of Combination
10 mmf.	9.5 mmf.
35 "	29.8 "
60 "	46.2 "
85 "	59.6 "
110 "	71.4 "
135 "	80.6 "
160 "	88.9 "
180 "	94.7 "
200 "	100.0 "
220 "	104.8 "
240 "	108.6 "

TELEVISION NOVELTIES

JOHN L. BAIRD, the Scotch television experimenter, recently brought out a novelty which may be expected to appeal to his countrymen; it is the simultaneous use of the same disc for scanning and as the reproducing diaphragm of a loud speaker, through magnets ranged around its rim which set up vibrations in the metal, even while it is spinning.

Another invention of his, which seems more practical, is the use of larger rectangular holes (oblong, instead of square) to scan the edges of the image, thus giving it a finer grain in the central portion. This corresponds to a similar central sensitivity of the eye. The image is also high and narrow, in the proportion of 7 to 3. Since March 31, speech and images have been broadcast together on the Baird system by the B. B. C. at London.

An interesting element in recent demonstrations is said to be the fact that a black-and-white effect, in the televised image, is produced by lighting the reception room with red lamps. This counteracts the pinkness of the neon glow-lamp, and produces a more natural effect on the screen.

EXTENSIVE SCHOOL RADIO

IN South Dakota plans have been announced to install radio equipment in all the five thousand schools of the State within the next two years, with a regular semi-weekly broadcast by the State Department of Education as part of the regular educational program. This should mean considerable business for some service organization or companies; and be suggestive to Service Men outside South Dakota.

MAIL COUPON TODAY!

SHORT WAVE CRAFT
96-98 Park Place, New York, N. Y.
As per your special introductory offer I enclose \$1.00
for which please print my subscription for one year
to SHORT WAVE CRAFT.

NAME

ADDRESS

CITY

STATE

100-7

Men Who Have Made Radio

(Continued from page 24)

advice and assistance. In this year, as the result of his experiments, he brought out the electrolytic detector, superior to any previous form of receiving device.

The new art was in a highly experimental condition. It had speedily become apparent, as soon as radio moved out of the laboratory, that its waves were capricious—or subject at least to capricious influences. What direction did the waves of a transmitter take? Ferrié obtained a military balloon, put a receiver in it, and moved it around and around a transmitter to measure the strength of the signal at every angle. The practical results of this work are still bearing fruit in our short-wave developments.

In 1902 the destruction of St. Pierre, in Martinique, by the eruption of Mt. Pelee ruptured communications to the neighboring French island of Guadeloupe. Ferrié restored them by installing radio equipment on the islands—the forerunner of many an emergency use of radio in great disasters.

His work of experiment was steadily prosecuted along the line of directional radio and the use of the loop, to study the manner of wave propagation. In 1904 he was awarded a prize offered for scientific research, and in 1912 another; while a doctorate of science from Oxford University and a laureateship from the French Academy of Science bear witness to the recognition of his work by other savants.

In 1909 the great Eiffel Tower station in Paris was installed, under his direction; and he turned it to account by the transmission of time signals, which serve not merely to regulate clocks, but also to determine positions on the earth's surface for more accurate surveying. He later served as secre-

tary of the international time conference.

In 1911 he organized the radio section of the Ecole Supérieure; and later his influence led to the foundation of the national radio laboratory of France.

In 1908, when Morocco broke out into actual war, Captain Ferrié had brought portable radio equipment into the field of actual warfare. In the following year, he installed transmitters on a dirigible and on airplanes. In 1914, having reached the rank of colonel, he was called upon to meet such problems as never before had been put upon a radio technician. He met the demands of four years of war, expanding his organization to meet the needs of war, and the development of practical radio under the exigencies of the unusual conditions encountered. In 1915 he introduced the use of ground telegraphy with equipment of low power, for short-distance communication without aerials. The development to a high degree of the vacuum-tube receiver, also, marked this period.

Since the war General Ferrié, Commander of the Legion of Honor, and with the Distinguished Service Medal of the American military forces among his almost innumerable decorations, has devoted his principal efforts to practical application of those principles of radio which he has done so much to develop, in the extension of the great network of radio communications which links France to her colonial possessions and to the rest of the world. He has, however, taken time often to write for the radio press, in France and abroad, in the interests of furthering radio science and encouraging the solidarity among radio devotees throughout the world which he hails as one of the strongest forces working for the furtherance of international understanding and peace.

Keeping Extraneous Noise Out of Sound-on-Film

(Continued from page 31)

out nicely in the studios, where the splicer made hundreds of patches per day and became very adept in his work. In the booth, however, it has not been so successful because, in most cases, the film must necessarily be patched in a minimum of time. Then, too, the number of experiences could not be compared to those of the professional patcher and therefore the degree of skill was lacking.

A new method, devised by the research laboratories of the Eastman Kodak Company, to block out the splices in sound film, is very effective and easy to follow. It consists of cutting a piece of black (opaque) film as shown in Fig. 1 and cementing it directly over the splice, as at A. The dimensions found most suitable for the patch are indicated at B; here A should be slightly under 1/4-inch; B, 5/16-inch; C, 1/8-inch; and D 1 inch. These patches may be made in quantity, for use when needed, and easily and quickly applied. It will be more convenient to handle them if a small cloth finger tab is attached to each by means of adhesive tape, as shown at C. The patch should cover the splice at its widest point;

it is best when the sound track is completely obscured for a distance of .098-inch each way from the center line of the perforation. This allows for a standard "full-hole" splice. It is advisable to have the patch extend inward almost to the picture frame. Then there is no danger of leaving part of the splice uncovered, by inaccuracy in mounting the patch.

Automotive Installation

(Continued from page 33)

radio, on the ground that it may distract the attention of the driver of the automobile. However, certain investigators have offered figures which would indicate that a car with a radio is driven more alertly and carefully than one without.

To return a moment to the tuning mechanism—attention should be given to the successful manner in which a major problem has been mastered. All set owners are familiar with the difficulty which may be experienced in trying to tune in stations, due to inexperience, or to vibration of the

Let RCA INSTITUTES start you on the road to Success in Radio



Radio Mechanic and Inspector, \$1800 to \$4000 a Year.

RADIO needs you... That's why the entire Radio industry is calling for trained men... That's why thousands of men who answered these advertisements are now earning from \$2,000 and up a year. Manufacturers,

broadcasting stations, aviation and radio are now eagerly seeking trained RCA Institutes men... Never before was there an opportunity like this in Radio.

This Is the Only Course Sponsored by the Radio Corporation of America

The RCA Institutes' Home Laboratory Training Course enables you to learn Radio in your spare time. In only an hour a day, you can obtain a thorough, practical education in Radio... You study right at RCA, the



Broadcast Station Mechanic, \$1800 to \$3600 a Year.

world's largest Radio organization. You learn Radio by actual experience with the remarkable outlay of apparatus given to every student. That's why every graduate of RCA Institutes has the experience, the ability and the confidence to hold a worthwhile Radio job.



Land Station Operator, \$1800 to \$4000 a Year.

Graduates of RCA Institutes Find It Easier to Get Good Jobs

SEND FOR THIS FREE BOOK... Read about these practical RCA methods of training that have prepared hundreds of men for success in Radio. Everything you want to know about Radio. Forty fascinating pages, packed with pictures and descriptions of the brilliant opportunities in this world-wide profession. RCA Institutes will back you up to the limit. Our catalogue is yours, free... SEND FOR IT TODAY!



Broadcast Operator, \$1800 to \$4800 a Year.

RCA INSTITUTES, INC.

A Division of Radio Corporation of America

Clip this Coupon NOW!

RCA Institutes, Inc., Dept. SRA-7
75 Varick St., New York, N. Y.
Gentlemen: Please send me your FREE 40-page book which illustrates the opportunities in Radio and describes your home laboratory-method of instruction.

Name.....
Address.....
State.....
Occupation.....

PATENTS

Protect Your Ideas

Write for Instructions,
free on request - - or
send drawing or model
for preliminary exami-
nation of Patent Office
records

Promptness Assured with
Best Results

Miller & Miller

PATENT ATTORNEYS

Former Members Examining Corps,
U. S. Patent Office
265 McGILL Building, Washington, D. C.



PATENTS TRADE-MARKS

DO NOT LOSE YOUR RIGHTS
TO PATENT PROTECTION

Before disclosing your invention to
anyone send for blank form "EVIDENCE
OF CONCEPTION" to be signed
and witnessed.

LANCASTER, ALLWINE & ROMMEL
(Registered Patent Attorneys)
475 Ouray Bldg., Washington, D. C.
Originators of forms "Evidence of Conception"



Radio's Greatest Value

1930 MODEL—LICENSED BY RCA
NATIONALLY KNOWN
SCREEN GRID
DYNAMIC WALNUT CONSOLE
A C ELECTRIC RADIO

Complete with
eight R C A li-
censed tubes. **\$39.50** NET

Write for Our Bargain Catalog
DIXON RADIO & ELECTRIC CORP.
110 E. 23rd St., N. Y. C., New York

An announcement of unusual
interest to every Radio Service
Man is to be found on page 8.
Be sure to turn to it now and
read it.

QUIT TOBACCO

No man or woman can escape
the harmful effects of tobacco.
Don't try to banish unaided
the hold tobacco has upon you.
Join the thousands of inveter-
ate tobacco users that have
found it easy to quit with the aid of the Keeley Treatment.

KEELEY Treatment For
Tobacco Habit
Successful For
Over 50 Years

Quickly banishes all craving for tobacco. Write today
for Free Book telling how to quickly Free yourself from
the tobacco habit and our Money Back Guarantee.

THE KEELEY INSTITUTE
Dept. L-703 Dwight, Illinois



receiver if it is portable. By applying a worm gear to the mechanism the problem is solved; motion of the tuning knob may be transferred to the shaft controlling the tuning condensers, perfectly, but the condenser shaft cannot move against the worm gear (a sort of automatic locking effect is obtained for all positions of the tuning condensers). This worm gear construction results in a "vernier" action which makes tuning very easy under all conditions; and, by careful machine work, backlash is made no longer a problem. The pinion shaft projects through the right end of the chassis on the dash and terminates in a small housing containing two small spiral gears serving to bring the shaft in proper relation to the control unit on the instrument board. (This is referred to in the caption at the right of Fig. B, in the May issue of RADIO-CRAFT.)

By this time the technician has probably realized that everything throughout this design has been developed with the first thought for rigidity. Further details will bear out such an observation. For instance, the old idea of using a loose wire for the aerial has been dismissed; and in its stead we find a capacitive aerial of the most solid possible construction. Two sheets of steel constitute the "condenser aerial," when mounted underneath the car chassis; the plates being the "high," or aerial side of the pick-up system and the chassis acting as the "ground." These two plates are, electrically, one after they have been bolted together to obtain the greatest possible length permitted by the available space underneath the chassis. It will measure approximately 30 inches in length and 8 inches in width. The greater the area of the capacitor plate, and the closer it is to the ground (yet keeping sufficient ground clearance), the louder will be the signals. Such an aerial minimizes possible signal fading due to its motion; and concentration of the signal pick-up in this manner reduces the chances for ignition interference.

"B" Power from a Storage Battery

(Continued from page 35)

be adequate to the high requirements.

With both switches open, connect the motor leads direct to the storage battery. Then close the motor switch and, when speed has built up near maximum, throw in the converter switch. Test with a speed indicator, removing the center support to do so; and then adjust the speed with the rheostat until it stands at not less than 2,000 r.p.m. Replace the center support, slightly open the rheostat; your A.C. from the slip rings will prove to be slightly less than 6 volts and (using a four-segment commutator) it will be 60 cycles. Currents of high frequency can be obtained but call for 6, 8 and 10 segments and higher speeds.

With a true-running shaft, constant-speed motor, and smooth commutator and brushes, you will be surprised at the even flow of current. Using a good eliminator you will put practically pure D.C. into the set and get as good results as from the lighting mains. A fully charged 150-ampere hour battery should run this converter for 30 hours before having to be recharged.

Classified Advertisements

Advertisements in this section are inserted at the cost of ten cents per word for each insertion—name, initial and address each count as one word. Cash should accompany all classified advertisements unless placed by a recognized advertising agency. No less than ten words are accepted. Advertising for the August 1930 issue should be received not later than June 9th.

CHEMICALS

BOOKLET OF EXPERIMENTS and chemical catalog, 15c. General Chemical Company, Box 397, Reading, Penna.

DETECTIVES

DETECTIVES Earn Big Money. Excellent opportunity. Experience unnecessary. Particulars Free. Write, George Wagner, 2190B Broadway, N. Y.

INSTRUCTION

LEARN TATTOOING. Instruction catalog, dime. Miller, N431 Main, Norfolk, Virginia.

INVENTIONS

INVENTIONS COMMERCIALIZED. Patented or unpatented. Write Adam Fisher Mfg. Co., 594 Earlight, St. Louis, Missouri.

MEDICAL

LOST VITALITY — The Specific Pill and Winchester's Hypophosphites, \$1.00 per box or bottle, postpaid, literature free. Winchester & Company, Established 72 years, Box 237, Mount Vernon, New York.

MISCELLANEOUS

TO THE MAN OR WOMAN seeking correspondence, matrimony or pen pals, we offer entirely different service. Box 1540, Sta. G, Los Angeles, Cal.

OLD MONEY WANTED

\$5 to \$500 EACH paid for Old Coins. Keep ALL old money. Many VERY valuable. Get Posted. Send 10c. for illustrated Coin Value Book, 4x6. Guaranteed Prices. We buy and sell. COIN EXCHANGE, Room 10. Le Roy, N. Y.

SONG POEM WRITERS

SONG POEM WRITERS. Composer of many "hits" offers real opportunity. Ernest Shonfield, 2236 Olive, D-20, Pasadena, Calif.

SONG WRITERS!



Substantial Advance Royalties are paid on work found acceptable for publication. Anyone wishing to write either the words or music for songs may submit work for free examination and advice. Past experience unnecessary. New demand created by "Talking Pictures", fully described in our free book. Write for it Today—Newcomer Associates, 751 Earle Building, New York, N. Y.

If your subscription to RADIO-CRAFT expires with this issue, surely you wish to continue to receive it regularly each month.

To those who act quickly, and send in their remittance of \$2.50 for one full year's subscription, we shall send them immediately one of the famous and most useful Tobe 4-Way Purpose Light Socket Aerial.

Write TODAY—send cash, check or money order for \$2.50 and your subscription will be renewed for one year, and the Aerial will be mailed immediately.

RADIO-CRAFT

98 Park Place, New York City

The Broad Frequency-Acceptor

(Continued from page 37)

The results obtained with Fig. 2, as compared with Fig. 1, were superior indeed. It was not long, however, before a fly in the ointment was found. While the response of low-wave stations had been increased about 100 per cent., something had apparently happened to the high-wave broadcasters. In fact, a certain station was almost entirely prevented from reaching the receiving set, as if the acceptor offered a dead spot to this particular station. Investigation showed this to be almost the case.

It seems that the inductance and capacity between the receiver and the aerial were resonant to a particular frequency which, as luck would have it, was exactly that of the station in question. This effect was produced by too great a capacity between ring and coil; the complete circuit, in other words, was acting as a series rejector to its own particular frequency.

To overcome this, there was at last evolved the circuit shown in Fig. 3; it was this, incidentally, that the author has named the "Broad Frequency-Acceptor." In addition to eliminating the previously mentioned disadvantages of the other circuits, it actually possesses volume-increasing properties.

In the development of circuit number three, the same secondary used in the previous experiments was retained; but the collector "ring," R, in this assembly, however, was changed in favor of a collector "coil," L4, made of No. 34 enameled wire. The proper coil design was obtained by winding the enameled wire *between* the turns of L2 for the full length of the "secondary" coil. The length of the collector coil may vary in some cases, depending upon the sensitivity of the receiver with which it is to be used. It may be found, for instance, that the removal of a half a dozen turns from each end will improve the characteristics of the acceptor. Once the proper value has been determined, it is advisable to apply several brush strokes of collodion, to hold the turns in place.

The theory of the broad frequency-acceptor is different from that of the two preceding experiments. While all the advantages of Fig. 2 are retained, its main drawback is done away with, namely, the step-down transformer action of the coil-to-ring assembly. Instead of step-down action and resistance losses introduced to broaden the band of desired frequencies, an open winding achieves the same end. The mutual capacity between windings being comparatively well distributed, the tuning is broader at all frequencies.

In this circuit the collector does not create losses, but acts rather as the third winding of a step-up transformer. The voltage impressed upon the collector coil is, of course, very much higher than that secured with either of the other circuits. The fact that the transfer medium is still capacitive, as well as inductive, accounts for this superiority. The wavetrapped action of the acceptor, absorbing a maximum quantity of energy from the antenna, also makes a vast difference.

In comparison tests the broad frequency-acceptor has been used in conjunction with

some half a dozen popular makes of receivers, operating under the most diverse conditions. In every case very gratifying results were obtained, and distant stations, barely audible before, came in with splendid volume, after the addition of the acceptor. On local stations the results were equally remarkable; since the broad frequency-acceptor brings in a desired signal almost 100 per cent. louder, it was possible to operate the receiver with its sensitivity set nearly at minimum, and still reproduce the program with normal volume. (In some sets this is a desirable feature.) The amplification of the receiver being so greatly reduced, atmospheric static was at a minimum, and local "commercial" static was, in the test cases, entirely eliminated.

The advantages of this device, when operating in conjunction with any standard receiver, may be summed up in a general way as follows; about twice the distance previously possible; extreme selectivity and freedom from station-heterodyning; reduced setting of the "volume control" at all times; reception of locals with a minimum of static and a total absence of industrial interference; and the reception of low- as well as high-wavelength stations, in normal proportion to each other. In this circuit, as in those preceding it, the 10-kilocycle band-selection remains unchanged at all frequencies.

A Tandem Band Selector

Fig. 4 shows two acceptors in "tandem"; this circuit gives unusually fine results, but the shafts must be insulated from each other for good results. The coils also should be shielded from each other, and the whole assembly incorporated in as large a shield box as possible.

Perhaps the most interesting variation of this circuit is that of Fig. 5. While it is not, strictly speaking, a variation of Fig. 4, it was found slightly more efficient. The antenna coil, L1, in this circuit is considerably larger, having 24 turns instead of 12. The secondary, L2, consists of 86 turns on a 2-inch tube; while coil L3 is composed of only 3 turns of wire, wrapped around the secondary near the antenna end of the coil. The frame and shaft of the condenser in Fig. 5 must be very carefully insulated from the ground, as in Fig. 4.

Three-Circuit Regenerative Set

For those desiring to construct a complete receiver, possessing high amplification and a good amount of selectivity, and retaining the advantages of band-pass action, the circuit in Fig. 6 is recommended.

The antenna primary, L1, consists of 20 turns of No. 28 D.C.C. wire; the secondary, L2, of 86 turns of the same wire. Coil L3 may be made by winding 20 turns of No. 34 enameled wire tightly around one end of the secondary, as shown in the diagram. The coil forms are 2 inches in diameter; except for the primary which is wound on a form which just fits inside the secondary and is placed at the low-potential end of it. Coil L5 is the secondary of a standard three-circuit tuner. In this case the num-



How to Build, Test, Repair, Maintain - - Radio Receiving Sets

The three volumes of this Library cover the entire field of building, repairing and "trouble-shooting" on modern radio receivers. The Library is up-to-the-minute in every respect and includes the very latest developments in the design and manufacture of equipment. The rapidly-growing interest in SHORT-WAVE RECEPTION is thoroughly covered in a complete section which deals with the construction of this type of apparatus.

Radio Construction Library

By JAMES A. MOYER and JOHN F. WOSTREL

Faculty, University Extension, Massachusetts Department of Education

Three Volumes — 993 Pages, 6x9
561 Illustrations

VOLUME I: presents the fundamental principles of radio so clearly and simply that anyone of average training will be able to read, understand and apply them. In one chapter alone, it gives actual working drawings and lists of materials for the construction of eight typical sets.

VOLUME II: fully discusses all of the elementary principles of radio construction and repair. An explanation of the necessary steps for "trouble-shooting," repairing, servicing and constructing radio sets successfully.

VOLUME III: covers the essential principles underlying the operation of vacuum tubes in a non-technical a manner as is consistent with accuracy. It discusses the construction, action, reactivation, testing and use of vacuum tubes; and an interesting section is devoted to remote control of industrial processes; and precision measurements.

EXAMINE these books for 10 days FREE

This Library is not only a thorough home-study course, but a handy means of reference for the more experienced radio experimenter, repair man, and radio shop-owner. To these men, as well as to those who desire to advance in the radio profession, this offer of a 10 days' Free Examination is made.

Simply clip, fill in, and mail this coupon

McGraw-Hill	
FREE EXAMINATION COUPON	
McGraw-Hill Book Company, Inc., 370 Seventh Avenue, New York.	
Gentlemen—Send me the new RADIO CONSTRUCTION LIBRARY, all charges prepaid, for 10 days' Free Examination. If satisfactory I will send \$1.50 in 10 days, and \$2.00 a month until \$7.50 has been paid. If not wanted I will return them at your expense.	
Name
Home Address
City and State
Position
Name of Company	R.C. 7-30



The MADISON

ILLINOIS AVENUE
Overlooking Boardwalk and Ocean

"A Hotel Distinctively
Different"

JUST COMPLETED IN

Atlantic City

Unexcelled Colonial
Hospitality

Now Ready for YOU

Fireproof — Showers and Baths
Throughout

From \$4.00 daily
European Plan

From \$7.00 daily
American Plan

FETTER & HOLLINGER, INC.
Eugene C. Fetter
Managing Director



Famous

For years as the hotel where courteous service, unexcelled food and comfortable rooms make a visit to Chicago a memorable event. The atmosphere prevailing is surprisingly homelike. Directly adjoining principal office buildings, shops and theatres.

Rooms, \$2.50 up—
with bath \$3.50 up

NEW
BISMARCK
HOTEL CHICAGO

Write for Booklet with city map

ber of primary turns on the primary coil will be reduced to six; a tap being taken at the third turn, and grounded.

The rest of the construction is standard; as in the use of a plate-circuit R.F. choke CH and its by-pass condenser C3, which may have a value of .00025- to .0005-mf. (depending upon the smoothness of regeneration desired). C4 is the usual plate-supply by-pass capacity, of one to six mf. Transformers T1 and T2 are A.F. units of any convenient type, and tubes V1, V2 and V3 are the usual '01A's. Condensers C1 and C2 are .00035-mf.

A Screen-Grid Receiver

The constants of the inductances shown in Fig. 7, in which a screen-grid tube is used, are the same as in the preceding circuits; as indicated by the designating numbers. The condensers used in the experimental model were Hammarlund "Midlines" of .00035-mf. capacity; C1, C2 and C3. It was decided to "gang" all of these and this was done by the use of a triple-section rod which was run through the three condensers. Although the circuits appear, from the diagrams, to be radically different in all respects, this is not true so far as the tuning is concerned; for the associated inductance and capacity values which resulted were such as practically to eliminate the need for a "trimming" condenser (although C4, a Hammarlund "Midget" of 5-plate size was

incorporated in the design). It will be observed that the special filter circuit requires special treatment of the condenser-gang connections. The required insulation of the circuits is obtained by use of insulating couplings between two of the rod-sections of the tuning condensers, C1 and C2, and also, because of the positive grid return of the detector grid circuit, between C2 and C3.

The rest of the circuit is standard and little comment on this portion of the receiver is required. Any standard screen-grid ('22-type) tube may be used for V1. Resistor R3 is a fixed unit of 15 ohms; while R2 is a 6-ohm rheostat, which acts, not as a volume control, but as a "sensitivity" control.

Volume control is obtained through the use of the 500,000-ohm resistor R4, connected in shunt to the secondary of T2.

Since L6 is in the plate circuit of the screen-grid tube, its inductance must be higher than the ordinary primary coil. The design was as follows: 90 turns of No. 30 S.C.C. wire, on a tube 1½ inch in diameter, placed inside and at the low potential end of L7, which has the same dimensions as L5 (90 turns of No. 28 D.C.C. wire on a 2-inch tube).

All R.F. coils must be carefully shielded, to prevent the slightest feedback; the shield should not approach any coil closer than two inches, and the spacing must be identical in every shield.

The Radio Craftsman's Own Page

(Continued from page 38)

handles should be fastened to the completed covers, to facilitate their removal; such as the small binding posts shown in the picture.

EDGAR R. SORENSON,
825 West 49th Street,
Los Angeles, Calif.

A TRICKY CIRCUIT

Editor, RADIO-CRAFT:

The circuit shown (Fig. 4) is an improvement on my single-tube short-wave set, which I operate without plug-in coils. I believe that it would be impossible to operate up to 550 meters, or higher, with but two coils. I consider that it is a super-regenerative DX getter. With a 10-megohm grid leak, 2,000-ohm phones, and the parallel condenser C3 to throw into circuit for longer waves, I have received W2XAF, CJRX, WBSN, W3XK, XDA, WCK, W6XN, and a London phone station.

The ratio is always in favor of grid turns: i.e., more turns on the grid coil in the ratio of eight to seven for those on the plate coil. This set, with a wider tuning range than plug-in sets, has a range from 20 to 30 meters when adjusted as shown. I have a sensitive set, and, I think, a good location.

MATT LUENNENS,

3950 Page, St. Louis, Mo.

(This is the kind of circuit that requires much ingenuity and unlimited patience, yet may give remarkable results in a good location. It is one which the experimenter must work out for himself; for it is impossible to lay down definite rules for a construction which can be expected to work anywhere, as with a standard circuit en-

playing more apparatus. Inquiries as to further details should be addressed to the constructor, as all constructional information furnished by him has been printed here.—Editor.)

LOW-LOSS HOME-MADE COILS

Editor, RADIO-CRAFT:

I am sending by parcel post a sample of the short-wave coils I use, and from which I get better results than from any other style. They are inexpensive and easy to make and will, I hope, be of interest to other short-wave fans.

S. THOMEN,
Sidell, Illinois.

(Mr. Thomen's coil, here illustrated, is

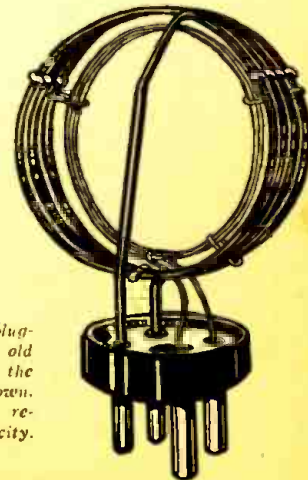

Fig. 5

Mr. Thomen's plug-in coil uses an old tube-base in the manner shown. Construction reduces self-capacity.

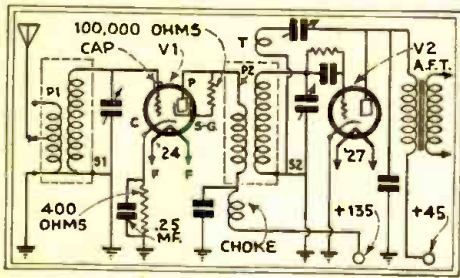

Fig. 6

The R.F. unit of Mr. Sherrell's receiver.

mounted on the bottom of a UX tube base, into the prongs of which its leads have been soldered. The secondary, $3\frac{1}{2}$ turns, No. 14 enameled wire, is $2\frac{1}{8}$ inches in diameter and connected across the "G" and "P." Tied to this with thread, so that it is held firmly in the approximate center, and at the "plate" side is a four-turn primary or tickler of No. 26 D. C. C. wire, $1\frac{3}{4}$ inches in diameter. The turns of the heavier coil are spaced about $1/16$ -inch by interwoven cord; those of the smaller wire are doped together so that they hold their shape with three-point support. The pin in the shortened tube base has been inserted by the constructor.—Editor.)

AN OLD CIRCUIT REVAMPED

Editor, RADIO-CRAFT:

Please find enclosed one of the old-time circuits that I have put the juice to; and believe me it will certainly shoot the ether. I thought perhaps some of the boys had forgotten the old set, and it might be well

to call their attention to it again. With proper shielding around home-made coils, this will compare favorably with any factory set. With only a 30-foot antenna, I can pull in the coast stations like a ton of brick.

RADIO-CRAFT is all right too; I mailed you my check yesterday. You know every babe knows its mother. With all best wishes for success.

A. E. SHERRELL,
Shamrock, Oklahoma.

(Mr. Sherrell's receiver, the tuner of which is reproduced here, uses a '26 first audio stage with 135 volts on the plate, and a '50 with 450 volts, all transformer coupled. It will be seen that he omits the by-pass usually deemed necessary from screen-grid to filament; and it is presumable that he has increased the impedance of P2 in the output of the first R.F. stage to suit the '24 tube.—Editor.)

A CHANGE OF MIND

Editor, RADIO-CRAFT:

Amending my article on "Installing Talkies in a Small Town," which appeared in the April issue of RADIO-CRAFT, I wish to say that a good modern dynamic is much superior to the air-chrome speakers used at first.

Remove from the speaker the output transformer, and install it in the booth, in a standard manner; get a phonograph volume control and put it in the auditorium, using the fader as a switch.

ROBERT HAVILAND,
Warrenton, Missouri.

Review of Recent Radio Literature

(Continued from page 41)

number of popular receiver models. The symptoms of a fault in the resistor, the purpose of the resistor, its connections, the color code used by the manufacturer, the value of the resistor and finally, the type of the "Durham" resistor (made by the publisher) recommended as a replacement, are arranged in successive columns. A page of diagrams gives fundamental resistor circuits and is backed by simple formulas.

It is hard to think of a more useful piece of advertising matter, or one which is more certain to be treasured and well thumbed. Seventeen well-known makes of receivers are listed; and the announcement is made that, as new receivers appear, additional sheets will be sent for incorporation in the book. The publishers offer the aid of their Service Department in supplying "information that you may desire on resistor applications or in connection with resistors required for receivers not included in this guide because of their relatively small distribution." This will be welcomed by the Service Man appreciatively—even though he may wonder whether Radiolas, Atwater Kent, Crosley and Majestic receivers are "not included, because of their relatively small distribution."

We think that this Replacement Guide has set a fashion. Now, if a condenser manufacturer will do likewise, there will be a good deal less unnecessary trouble for the Service Man.

POLYMET ENGINEERING MANUAL.

Loose-leaf folder, 27 sheets, with diagrams, illustrations and tables. $8\frac{1}{2}$ by 11 inches. Published by Polymet Manufacturing Corp., New York City. Distributed to the radio industry.

This interesting compilation covers condenser specifications, design, application, tests and measurements; resistor construction and characteristics for both fixed and variable types; coil constants and formulas, and constructional descriptions of choke

coils, audio and power transformers, reproducer field coils, ignition and magnet coils, etc. Sizes are illustrated by detail diagrams for those who have to figure layouts of commercial apparatus. Graphs, wire tables, etc., give the book permanent reference as well as commercial value. Since this expensive work is intended for manufacturers and engineers, any radio executive desiring to receive a copy should use the letterhead of his company.

SUGGESTIONS AS TO HOW COMMUNITIES MAY ATTACK THE PROBLEM OF MINIMIZING RADIO INTERFERENCE. 8-page folder, 6 by $9\frac{1}{2}$ inches. Published by Tohe Deutschmann Co., Canton, Mass. Price, 10 cents.

The lengthy title of this small, but meaty, production, sufficiently indicates its scope. In the campaign against unnecessary noise, those who are most familiar with the technical problems are unable, alone, to carry on the campaign. In order to compel the owners of nuisances to muzzle them, the Service Man must be able to enlist the organized support of the set owners of a community. A suitable organization can defray the cost of detecting the causes of interference and bring moral, legal or other suasion as needed, to bear upon those responsible; while a single crusader would merely come to grief.

The booklet contains specimens of the forms needed in the organization of such a radio listeners' club, a typical anti-noise ordinance, and other practical information. During the past few months the Tohe Deutschmann Co. has been sending into the field, where requested, a trained interference engineer to cooperate with municipalities and local organizations who wish to make a thorough job of noise suppression. A typical report of this kind, which is before us, is quite interesting, and will form the basis of a future article in RADIO-CRAFT.



All Tubes Perform Better-Last Longer When AMPERITE Controlled

Radio tubes perform at their best, when controlled by AMPERITE. AMPERITE automatically regulates tube voltage more accurately than is possible with hand rheostats or fixed resistances. For all tubes—A.C. or D.C.

\$1.10, with mounting (in U. S. A.) At all dealers.

AMPERITE Corporation
661 BROADWAY, NEW YORK

FREE—"Amperite Tube Chart." Write Dept. RC7



AMPERITE
The "SELF-ADJUSTING" Rheostat

MORE MONEY DAILY FOR YOU!
SHIRTS UNDERWEAR TIES

Men and Women—Industry's leader offers you direct-to-wearer agency. Pays big. Happy work. Thousands successful. Sample outfit free. Start at once. Write today.
DEPT. CARLTON MILLS, INC.
597-M 79 Fifth Ave., New York, N.Y.

DO YOU WANT TO STOP TOBACCO?

Banish the craving for tobacco as thousands have. Make yourself free and happy with Tobacco Redeemer. Not a substitute, not habit forming. Write for free booklet telling of injurious effect of tobacco and dependable, easy way to relieve the craving many men have.

FREE BOOK
Newell Pharmaceutical Co.
Dept. 928 Clayton, Mo.

Aluminum Box Shields
Beautiful silver dip finish, 5 x 9 x 6 inches, \$1.89.
16 x 6 x 14 inches, \$3.95
We make any size to order in 24 hours.
Genuine Baldwin Type "C" Phones, a necessity for short-wave reception, \$3.65 a pair.
Test Leads, 3 ft. long, hard rubber sleeves, 59c.
Bakelite neutralizing screwdrivers, 50c.
BLAN THE RADIO MAN, INC.
89J CORTLANDT ST. NEW YORK

RADIO BARGAINS

Low Power Transmitter adaptable for phone or cord. With plug-in coils \$14.75
Short Wave Sets, one tube complete with 5 coils, 14 to 550 meters 6.45
B Eliminator, Ione Dry with 280 tube, 180 volts, will operate up to ten tube set, fully guaranteed 6.75
A B C Power Packs 8.75
Power and Filament Transformers 4.00
Tubes: UX type, 30-day replacement guarantee, No. 210, \$2.25; No. 251, \$2.35; No. 281, \$1.85; No. 245, \$1.25; No. 224, \$1.25; No. 227, 75c; No. 225, 65c; No. 171, 75c.
Chas. Hoodwin Co., 4210 Lincoln Ave., Dept. G-15, Chicago

PATENTS Write for Free Guide Book. "HOW TO OBTAIN A PATENT" and Record of Invention Blank. Send model or sketch and description of your invention for our Free Opinion whether it comes within Patent Office Rules. RADIO and ELECTRICAL Cases a Specialty. Prompt, Efficient Service.
PAYMENT OF FEES IN INSTALLMENTS
VICTOR J. EVANS & CO., 923-9th, Washington, D. C.

MAKE BIG MONEY

Just out. Lights gas instantly without sparks or flame—Sells like wildfire wherever gas is used—Retals for 25c.
MYSTERY GAS LIGHTER

PACKED ON INDIVIDUAL CARDS WITH INSTRUCTIONS
Sample free or rush \$9.00 per 1000 or \$1.00 per dozen. NEW METHOD MFG. CO., Desk SFG-7, New Method Bldg., Bradford, Pa.

When Your Tubes Have Three Lives

Like the proverbial cat, your tubes can have several lives. It's just a question of treatment. If your A.C. tubes last less than six months, you are throwing away six to twelve months of full normal life. Charge it to EXCESSIVE line voltage.

If your set sours early in the evening, when folks turn on lights and radios, blame it on LOW line voltage.

In either event, it now becomes your fault. Because, by investing the small sum of \$1.75, you can overcome the effects of high and low line voltages forever. Here's how:

Automatic Line Voltage Regulator Clarostat

Its name tells the story. Compensates for all line voltage fluctuations. Applied to attachment plug of usual A.C. set—no tools, fussing, experience. AUTOMATIC—provides immediate change in compensating resistance for all voltages. No taps, switches, worry. Neat. Compact. DIFFERENT.

Install it—forget it—and save the price of two or three sets of A.C. tubes per year—and perhaps a costly power pack failure.

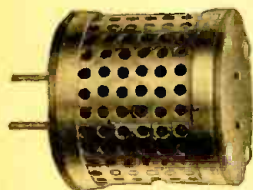

ASK your dealer to show you the greatest investment in radio today—the AUTOMATIC Line Voltage Regulator Clarostat. But beware of substitutes!

Watch out for switching! Demand what you ask for.

CLAROSTAT MFG. CO., INC.
Specialists in Aids to Better Radio
285-7 N. 6th St. :: Brooklyn, N. Y.

IF you are a Service Man, then surely you will be interested in qualifying for membership in the *National Radio Service Men's Association*. Complete details will be found in the announcement on the page facing the editorial in this issue.

Radio Craft's Information Bureau

(Continued from page 42)

cases, the generator will have to be removed in order to make the change of connections. This pointer may save some Service Man needless work checking through a circuit that is apparently O. K.

(A.) The solution of this problem lies in the fact that the polarity of the output of the generator is dependent upon the polarity of the exciter current through the field coils of the generator of practically every car on the market (as we are advised by the Chief Engineer of the Continental Wireless Supply Co., which has developed the receiver here described); and this polarity, in turn, is dependent upon the polarity of the battery to which it is connected.

Installation procedure would be as follows: If the car battery has "A+" grounded to the frame of the car, the next step is to lift the battery out of the battery box and turn it half-way around (if, as may be found in a few instances, the leads are "polarized," it will be necessary to resolder the lead-ends accordingly), and then reverse the connections to the ammeter. If the meter now reads "discharge" with only the car lights turned on, all is well; if it doesn't leave the zero mark, "flash" the field coils for a couple of seconds, to kill the residual magnetism, by pressing down the cutout relay arm. The connections to a standard generator are indicated in Fig. Q70. To overcome the residual magnetism of the core, the battery must, of course, be well charged; and all the connections must be tight.

THE "PERIDYNE" CIRCUIT

(71) Mr. Ed. Young, Long Island City, N. Y.

(Q.1) Please advise why the "C" bias for the power tube ("34") in the "A.C. Screen-Grid Peridyne" receiver (as illustrated in the September, 1929, issue of RADIO-CRAFT) reads positive, instead of negative, in polarity?

(A.1) The polarity of this potential was apparently reversed in drawing the original schematic circuit, as you state. To correct this, follow the changes indicated in the accompanying diagram (Fig. Q71). Instead of grounding the grid return lead of tube 34, where it leaves transformer 48, remove this wire from ground and connect it to the "C-" side of resistor 44A, as indicated by the dotted line. Then, instead of running the center-tap connection of the 5-volt filament winding to the "C-" side of resistor 44A, remove this lead, as shown; and instead connect it to the "C+" or grounded tap on the voltage divider (at the point marked 44B).

(Q.2) On page 556 of the May, 1930, issue, in the article, "Zenith 16E," the detector plate-circuit resistor is shown as 1.0 megohm, but the text refers to a plate potential of 50 volts. Is this correct?

(A.1) Although Zenith Bulletin No. 15 shows this value, too, we are advised by the author of the article, Mr. Cook, that this resistor has a value of 0.1-meg., as measured.

GEO. C. MILLER'S "PORTABLE LABORATORY"

(72) Mr. Fred C. Nicholls, Cle Elum, Wash.

(Q.) I started to build a test set in accordance with the instructions given by Mr. Geo. C. Miller, in the January and February issues of RADIO-CRAFT ("A Complete Portable Testing Laboratory"). The D.C. meter came equipped with an external resistor for the 200-volt range. I ordered also the 120,000-ohm resistor R5, the 72,000-ohm resistor R4, and everything else listed. Now, I want to ask this: why get a fellow to spend a lot of money buying something he does not need? Why the 192,000-ohm resistor with the bi-polar switch if R5 and R4 are to be used; and why R5 and R4 if an external resistor is furnished with a Weston "D.C. 301" 0-8-200 voltmeter? In plain English, I have three sets of resistors for the same job. I am ready to soak up any radio knowledge that comes my way, but I guess I will have to get an expert to interpret RADIO-CRAFT diagrams. If my criticism is in error, please let me know where I am wrong.

(A.) Mr. Miller (who is a resident of Seattle, Washington) advises us as follows: "The trouble Mr. Nicholls experienced was due to the fact that he did not read the article with sufficient care and order his parts exactly as specified; he missed that word "or" in the text.

"We built our first testers without R2 and R3 in

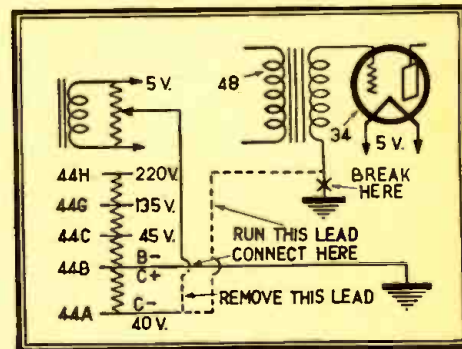

Fig. Q71. The corrected diagram of the power-tube biasing connection of the A.C. Screen-Grid Peridyne.

them; and we burned out our D.C. voltmeter the first day by accidentally swinging the bi-polar switch to the high-voltage contacts before we set switch 8 in the proper position. In fact, switch 8 will permit a reading of only 200 volts, maximum; and this is not nearly enough for most testing. Therefore, instead of adding a rotary switch to cut in additional resistors (which still would not solve the burn-out problem), we finally conceived the idea of splitting the track and inserting the 200-volt-scale resistor. This made it possible to swing the bi-polar switch into any position without danger of burn-out.

"As for leaving out R4 or R5, that is impossible. How else would it be possible to measure voltages above 8? They are there to increase the range of the first seven positions of the bi-polar switch, when needed; R2 and R3 automatically increase the range for the last two positions."

As this point in the construction of the "Complete Portable Radio Testing Laboratory" was not clearly understood by several other readers, we provide here a diagram (Fig. Q72) which should clarify this detail.

MORE QUESTIONS ABOUT THE "PORTABLE LABORATORY"

(73) Mr. A. E. Ellison, Ilwaco, Washington.

(Q.1) Referring to Mr. Miller's article, permit me to ask the following questions:

(A) From the Weston catalog for 1930 I note that the bi-polar switch does not contain any resistance. Therefore, I am led to suppose that I must use R5, 120,000-ohms and R4, 72,000-ohms, external to the switch, as per diagram on page 304.

(B) Should not switch 11 be S.P.S.T. and not S.P.D.T., as listed?

(C) From whom are resistors R4 and R5 obtainable, and what is the current-carrying capacity?

(D) In the January issue R7 is shown as 0.14 and also 1.14 ohms—which is correct?

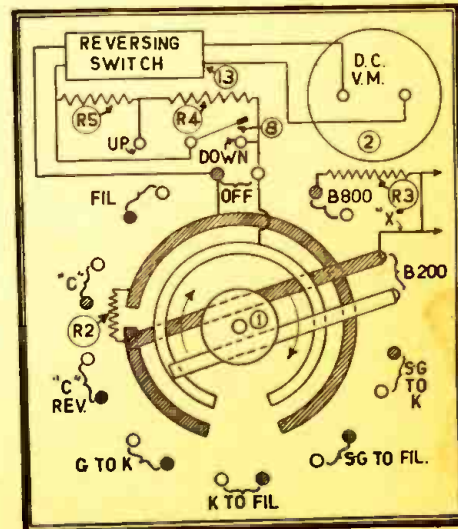

Fig. Q72. A part of the diagram of the Portable Testing Laboratory, showing the positions of resistors mentioned in the queries.

(E) In the February issue there is shown an instrument marked VCN—what is this?

(F) For what is the manganin wire, mentioned in the article, used?

(A.) The answer to the inquiry of Mr. Nicholls, given above, should answer section A of this query. In addition, Mr. Miller writes: "It is cheaper to order R2 separate, although it is more convenient to order this unit direct from Weston; order as 'one Weston bi-polar switch complete with 192,000-ohm internal resistor.' Please note this resistor is for a 1000-ohms-per-volt meter only; and of course the internal track of the bi-polar switch must be changed, as described, to permit the insertion of this resistor at the proper point in the circuit. It will not be necessary to split the track in the switch, if R2 is connected in one side of the B-200 circuit, at the point marked 'X' in the accompanying diagram, and R3 is changed to 792,000 ohms." (Consult Fig. Q72).

(B) "Switch 11 may be either S.P.S.T. or S.P.D.T., as only one side is used; the latter was handy."

(C) "Resistors may be obtained from any firm guaranteeing an accuracy of about 1%. Wire-wound units are used; the nearest higher value is ordered and the wire unwound until exactly the right value is obtained. This may be done by using an ohmmeter; by using a tested voltage supply and watching the needle until correct reading is obtained; by taking the resistors to a local high school laboratory; or by stating your needs to a reliable meter maker, who can then make the resistors to the values specified."

(D) "The correct value for R7 is 0.14 ohms."

(E) "VCN is a variable condenser with a maximum capacity of about 125 mmf."

(F) "Manganin holds its resistance calibration well; nichrome may be used; even copper will do, if the spool holds sufficient to give proper deflection."

Radio-Craft's Opportunity Column

TO make this magazine of additional benefit to Service Men, RADIO-CRAFT has instituted a new feature, of which advantage may be taken, free of charge, by any Service Man who has enrolled himself in the NATIONAL LIST OF RADIO SERVICE MEN (by filling out in full the blank which is printed in every issue of this magazine). We will print short notices of the same nature as those which follow; and will forward to the writer of any of them the replies which may be addressed to him (by the number given) in care of RADIO-CRAFT. We can undertake to publish the same notice only once.

We must reserve the right to condense all letters into their most essential details; and we urge all our correspondents who use this service to be as concise, though thorough, as they would be in the composition of a paid advertisement which would cost them several dollars.

Service Men seeking employment should give, at the beginning, the important details which an employer will first ask; and anyone offering employment to a Service Man should be equally specific.

It is desirable that references be given in all letters seeking employment, etc.—not for publication, but in order that RADIO-CRAFT may verify the statements made, if requested to do so, by parties interested in replying to the advertisement.

Please give all information for publication on a sheet of paper separate from the questionnaire, which is filed by us. Age, years' experience, domestic affairs, etc.; and do not forget to put your name and address on each sheet. We have several requests lacking these important details, which we cannot publish as yet. A period of at least one month must elapse between receipt of letters and publication; as the forms of RADIO-CRAFT close several weeks ahead.

We cannot publish under this heading any advertising of a commercial nature—for the sale of goods, or instruction, etc.; or for an employment agency. We cannot publish offers of general servicing for the public, or service representation of a manufacturer in a district. For the former, local advertising mediums are available, and as to the latter, a manufacturer requesting such information will be given it directly from the files of the NATIONAL LIST OF RADIO SERVICE MEN. Announcements seeking or offering regular employment, however, will be accepted under the conditions stated above.

FROM AN ENGLISH SERVICE MAN

Editor, RADIO-CRAFT:

I enclose the form from the April issue of RADIO-CRAFT, duly filled in with my qualifications. I may add to the information therein that I have a good experience of mains receivers, especially D.C., having recently left a small manufacturer. My reason for sending this in is that I contemplate coming to the U. S. A. at some future date, and this may be a useful introduction.

RADIO-CRAFT is by far the most interesting book I have ever struck, and it is a real treat after the amateur papers we have to put up with here. In this country radio Service Men are almost unknown, and everybody potters around with their own gear. And what beautiful receivers you have there! I'm afraid anything approaching their price-class would have a very small market here, though. What would you think of our two- and three-valve (tube) receivers which are universal here?

However, you might be surprised with what they can do. I have handled a few American receivers, and must say they are clever jobs; but I'm sure our "valves" can beat your "tubes." It's very strange to us that you do not publish characteristics with your tubes; as amateurs here scarcely buy a valve without working out its exact grid-swing, plate current and impedance beforehand.

I should be glad to communicate with any RADIO-CRAFT reader in the U. S. A., as I'm sure we could interest each other.

L. P. DISMORE,
80 Whitegate Road,
Southend-on-Sea, England.

(The "amateur," on the other side of the water, is a set builder, or even a mere broadcast listener. The range of battery-operated valves or tubes is much wider there, also. As for prices, without knowing the discounts, we notice list prices on three-tube sets in England comparing with those of six- and seven-tube outfits here.—Editor.)

The writers of any of these requests may be addressed as Opportunity No. (number given below), in care of RADIO-CRAFT, 98 Park Place, New York City.

(Opportunity 68) Service Man, four years' experience on all makes of sets, has also office experience, wishes position with jobber or dealer, Chicago or Northern Indiana. (Indiana)

(Opportunity 69) Young man, N. R. I. student, wishes to make connection with radio laboratory where he can work under experienced direction. (Kansas.)

(Opportunity 70) Service Man, working for self at present, wishes to secure position in New York City or traveling. Married. (New York.)

(Opportunity 71) Service Man, specialist in short-wave set building, would like to make permanent connection with Latin-American or South African firm interested in the short-wave field. (Texas.)

(Opportunity 72) Service Man, naval radio and amateur operator, stenographer (railroad service), custom builder, eight years' experience, has testing equipment, would like to make connection with dealer or manufacturer. Will move if worth while. (Georgia.)

(Opportunity 73) Graduate electrical construction course, five years' radio study and custom building, seeks servicing position at close of school year. Age 20. (Massachusetts.)

(Opportunity 74) Service and sales manager, eight years in automotive accessory and six years in radio, high school, two years' college and N. R. I. course, desires position with manufacturer, as territorial Service Man, preferably. Age 34. Married. (Kentucky.)

(Opportunity 75) Radio Service Company invites manufacturers to send price and discounts on merchandise of interest to the radio and electrical trade. (Baltimore.)

(Opportunity 76) Service manager, six years' service experience, graduate School of Engineering, has equipment, desires position as field Service Man for manufacturer. Will pay expenses to factory for special training if necessary. Asso. I. R. E. Age 22. Married. (St. Louis.)

(Opportunity 77) Service Man, desirous to arrange with manufacturer for servicing in territory, will take special training at factory. (Northwest Pennsylvania.)

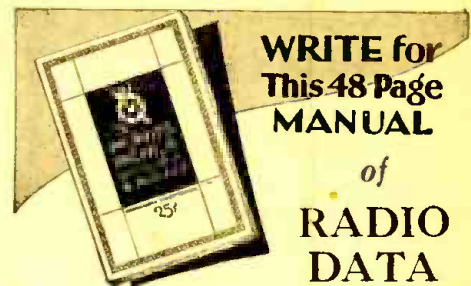

WRITE for
This 48 Page
MANUAL

of
RADIO
DATA

For

CUSTOM-BUILDERS
and EXPERIMENTERS

Contains valuable information on
Band Filters, Screen-Grid Amplifiers,
Push-Pull Audio Amplifiers,
Power Packs, Unit Construction,
Shielding, Cabinets, Installation and
Servicing, as used in the famous
"HiQ-30" Custom-Built Radio:

Fully illustrated, including Gravure
Insert of cabinet designs.

SEND 10 CENTS TO
COVER MAILING

Write for it today.
Use the convenient coupon.

Hammarlund-Roberts, Inc., Dept. RC7,
424-438 W. 33rd St., New York, N. Y.
Enclosed 10¢ (stamps or coin) for "HiQ-30" Manual.
Name.....
Address.....

FREE!
RADIO BARGAIN
CATALOG

ALSO FREE RADIO GIFT

Send now for this
new free radio catalog
which saves you many dollars on
radio outfits, kits, parts, tubes and accessories! Also
TIME CONVERSION CHART FREE. Tells you instantly
what time it is in any part of the world!
Given free if your request for catalog reaches us
this month.

20th CENTURY MAIL ORDER CORP.

202 JACKSON ST., CHICAGO, ILL.

Genuine PILOT Products

Know
RADIO!

Membership in the ELECTRAD FORUM opens to you the world of radio research and experiment. It is an organization of earnest radio workers who exchange ideas and experiences. Dues, \$5 per year. Include unique monthly magazine of inestimable value. Write Dept. RC7 for details and application blank.

John F. Rider
DIRECTOR

ELECTRAD FORUM
1440 Broadway - - - New York

An interesting announcement of the new scientific-mechanical-technical magazine is to be found on page 59 of this issue.

RACON PRODUCTS

Famed Throughout the World for most Natural Sound

RADIO THEATRE PUBLIC ADDRESS

AEROPLANE REPRODUCTION



New Racon Junior Electro-Dynamic Type Horn Unit

The Racon Electro-Dynamic Type Horn Unit for radio combines the rich full tones of the dynamic type with the clearness and distinctness, without distortion, of the horn type.



Racon AEROPLANE HORN

Through the Racon Aeroplane Speaker the broadcaster's voice can be heard for miles. Even though the plane may be hidden in the clouds, the voice or music can be heard above the din of city traffic. During the Chicago tests music was broadcast from a phonograph record and heard clearly miles away.



Baby Electro-Dynamic Type Horn Unit List Price, \$35.00



The New Unit

This revolutionary change in the type speaker for radio use is but slightly higher priced than the ordinary speaker, but is unrelentingly better. Tests prove it. Write for descriptive catalog.

The Largest Horn Speaker Manufacturers in the World

RACON Elec. Co., Inc.

18 WASHINGTON PLACE NEW YORK

Slough, Bucks, England, and 3 Mutual Street Toronto, Canada

Don't Forget!

Visit our Booth A-39 and Demonstration Room C.C. 19 at RMA Trade Show at Civic Auditorium, Atlantic City, New Jersey, Week of June 2nd to 6th.

Letters from Short-Wave Fans

FOREIGN STATIONS

Editor, RADIO-CRAFT:

A letter from Motala, Sweden, states: "Our short-wave transmissions are not regular but, usually, weekdays 1130 to 1200 GMT, weather reports and time signals; 1600 to 2130, speech and music; holidays, 1000 to 2200, sometimes with a pause from 1200 to 1400. The wave is 49.46 meters (6062 kilocycles) and the output one-third kilowatt."

I suppose you have heard from fans on the *Electra*, Marconi's ship, on 25.70 meters. K1XR, Manila, is now on 25.36 also.

Just before typing this, I heard CFA, Drummondville, on 22.70 calling "Alamo, Americ, bound from Southampton to New York." I suppose that is a new ship going on the air. DDX on the *Europa*.

ARTHUR J. GREEN,
International Short Wave Club,
Box 713, Klondyke, Ohio.

Editor, RADIO-CRAFT:

I have received from PCJ, Eindhoven, Holland, their schedule: it is now 1800 to 2000 and 2300 to 0000 GMT Thursday; 0000 to 0300 and 1800 to 2000 GMT Friday; and 0000 to 0600 GMT Saturday. Their frequency is 9,590 kilocycles (31.26 meters).

DONALD HAUPT.

646 East 62 St., Indianapolis, Ind.

(NOTE: Greenwich Mean Time [GMT] is written without a space between hours and minutes: it runs from 0000 [midnight] and numbers the hours from noon on, consecutively; that is, 2359 is one minute before midnight. It is five hours faster than Eastern Standard Time; six hours faster than Eastern Daylight Time or Central Standard Time; and so on for the different time zones.

For example, to convert 1950 GMT to Eastern Standard Time, subtract 500. Since the result is greater than 1200 [noon] subtract again 1200 to obtain the hour of the afternoon. Then point off the hour and minute.

1950 — 500 = 1450
1450 — 1200 = 250

Answer, 2:50 p.m. E. S. T.

For Mountain Standard, first subtract 700; and for Pacific Standard, subtract 800. 1950 GMT is therefore 11:50 a.m., PST.—Editor.)

CORRESPONDENTS WANTED

Editor, RADIO-CRAFT:

One of the leading theatres here has installed a radio, and every night they broadcast Amos 'n

Andy through the theatre's sound system; this attracts fans who would otherwise stay home to listen to them. Of course, there are other good things on the air; and it is good for radio sales.

Is it necessary to enclose return postage when writing for verifications?

(It is desirable to enclose an International reply coupon, which may be obtained at the postoffice, when writing to foreign countries. Some of the larger stations have discontinued the practice of acknowledging ordinary reports, because of the increasing number of short-wave listeners.—Editor.)

I would like to correspond with other short-wave fans. I am sixteen.

THOMAS PHILLIPS, JR.,
1021 St. George St.,
East Liverpool, Ohio.

I am going to build a short-wave transmitter, and would be glad to hear from hams about construction, and a good transmitting antenna.

S. LONIGRO,
1969 First Ave., New York, N. Y.

I would like to correspond with other short-wave fans, especially in foreign countries, and will answer all letters.

BRUCE GREEN,
1355 Caroline Ave., Clinton, Iowa.

I would like to correspond with other experimenters and radio Service Men; also foreign radio fans.

WALTER HAWKINS,
Box 50, Route 1, Wakarusa, Ind.

MARCONI'S EXPERIMENTS

THE recent telephone experiments of Marchese (Marquis) Marconi in communicating from his yacht, now cruising along the Italian coast, with different parts of the world on comparatively low power have been heard directly by short-wave listeners, and a few days ago a conversation between Marconi and station W2XAD, Schenectady, was re-broadcast through the N.B.C. chain. Remarkably clear reception was obtained. Marconi stated that his power is but 750 watts, supplied by storage batteries. This is the transmitter by which he recently sent a signal to Australia which turned on the lights of an exposition.

Marconi also announced that a short-wave transmitter is being constructed under his personal direction for use in Vatican City (Rome) by the authorities of the Catholic church, and possibly for world broadcasts by Pope Pius XI.

Short-Wave Stations of the World

(Continued from page 30)

Meters	Kilo-cycles	Station	Notes
50.70	5,300	AGJ, Nauen, Germany.	Occasionally after 7 p.m.
55.00	5,170	OKIMPT, Prague, Czechoslovakia.	Tues. and Fri., 2:30-4:30 p.m.
60.00	4,920	LL, Paris, France.	
61.22	to 62.50	W8XK, Pittsburgh, Pa.; WIXAY, Lexington, Mass.; W2XB, Beacon, N. Y.; WENR, Chicago, Ill.	Television.
62.56	4,795	W9XAM, Elgin, Ill.	
62.69	4,785	Aircraft.	
65.23	to 66.67	W9XL, Chicago, Ill.	Television.
67.65	4,430	W6XC, Los Angeles, Calif.	
70.00	4,280	DOA, Doberitz, Germany.	6 to 7 p.m. 2 to 3 p.m. Mon., Wed., Fri.
71.77-72.98	4,180-4,100	OHKZ, Vienna, Austria.	Sun., first 15 minutes of hour from 1 to 7 p.m.
72.87	4,116	RA97, Khabarovsk, Siberia.	5-7:30 a.m. Aircraft.
74.72	4,105	W00, Deal, N. J.	
80.00	3,750	NAA, Arlington, Va.	Time signals 8:55-9 a.m. 9:55-10 p.m.
82.90	3,600	F8KB, Constantinople, Tunis, Africa.	Mon. and Fri.
84.24	3,560	DOA, Doberitz, Germany.	Tuesday and Fri. after 6 p.m.
84.46-85.66	3,550-3,500	DOA, Doberitz, Germany.	Amateur Telephony.
86.50-88.00	3,400-3,400	W9XL, Chicago, Ill.	Aircraft.
92.50	3,250	WCK, Detroit, Mich.	(Police Dept.)
94.76	3,166	W00, Deal, N. J.	
95.48-97.71	3,142-3,070	W00, Deal, N. J.	Aircraft.
98.03	3,124	W00, Deal, N. J.	
98.95	3,030	W00, Deal, N. J.	
101.7	to 105.3	W3XX, Silver Springs, Md.	8 to 9 p.m. except Sunday; WPY, Allwood, N. J.; W2XR, New York, N. Y.; W3XL, Bound Brook, N. J.
104.4	2,870	W6WF, Perth, Australia.	
105.3	to 109.1	W3XX, Silver Springs, Md.	Television.
		W3BA, Newark, N. J.; Tues. and Fri. 12 to 1 a.m.; W2XCL, Brooklyn, N. Y.; W8XA, Pittsburgh, Pa.; W1XB, Som-	

Meters	Kilo-cycles	Station	Notes
109.1	to 113.1	W9XAP, Chicago, Ill.	Television.
110.2	2,722	W2XCR, Jersey City, N. J.	8:15 and 9 p.m.
113.5	2,645	W2XB, Long Island City, N. Y.	Television.
124.2	2,416	W9XR, Chicago, Ill.	
125.1	2,398	W9XR, Chicago, Ill.; W2XCU, Amberg, N. J.	
128.0-129.0		Aircraft.	
129.0	2,325	W10XZ, Airplane Television.	
131.3	2,285	W2XBO, New York Central R.R. train.	(Exp.)
136.4	to 142.9	W8XAU, Pittsburgh, Pa.; W1XB, Somerville, Mass.; W2XCW, Schenectady, N. Y.; W1XAU, Boston, Mass.	Television.
142.9	to 150 meters	W2XCL, Brooklyn, N. Y.; Mon., Wed., Fri., 9 to 10 p.m.; W9XAA, Chicago, Ill.; W2XBS, New York, N. Y.; frame 60 lines deep, 72 wide, 1,200 R.P.M.; W1XAE, Springfield, Mass.; W8XAU, Pittsburgh, Pa.; W6XAM, Los Angeles; W2XBU, Beacon, N. Y.; W3XAK, Bound Brook, N. J.; W3XK, Washington, D. C.	Daily except Sun. 8 to 9 p.m.; Allwood, N. J.; W10XU, Airplane.
150	2,000	RA72, Simolensk, USSR	
149.9-174.822	2,000-1,715	W2XBO, Long Island City, N. Y.	Amateur Telephony and Television.
175.2	1,712	W8XU, Cincinnati, Ohio.	(Police Dept.)
		WRBH, Cleveland, O. (Police Dept.)	
		KGJX-Pasadena, Calif. (Police Dept.)	
		St. Quentin, France.	
		FBFY, Cannes, France.	
178.1	1,684	WDDX, New York, N. Y.	(Police Dept.)
184.6	1,608	W9XAL, Chicago, Ill. (WMAC) and Aircraft Television.	
187.0	1,604	W2XCU, Newark, N. J.	
		W2XCU, Wired Radio, Ampere, N. J.	
		W2XCD, DeForest Radio Co., Passaic, N. J.	
196	1,530	W10XZ, Airplane Television.	
187.9	1,596	WKDT, Detroit, Mich. (Fire Dept.)	
		(Standard Television scanning, 48 lines, 900 R.P.M.)	

NOW = on all newsstands

Remember that EVERYDAY MECHANICS stands for practical mechanics in all its phases. And still more important, this magazine is the only one ever published where nearly all of the material published is edited with the view that its readers can cash in on the ideas.



15c
The Copy

HERE is the latest and most up-to-date magazine of its kind that has ever been published. Edited by Mr. Hugo Gernsback, veteran publisher of radio and scientific magazines for over 20 years.

The new magazine is chock-full of the latest inventions, new developments, how-to-make-it material, home mechanics, woodworking, metal craft, radio experimentation, etc.

But the important point about this new magazine is that it is thoroughly practical from beginning to end. No theories, no scientific accomplishments, no reading material that is not 100% practical in everyday life.

The magazine contains dozens of valuable articles showing how you can make things not only for yourself but how you can make money out of them immediately—that's the big thing.

The first issue of this magazine is now on all newsstands. Or if you wish to take advantage of several fine offers for a year or two-years' subscription, fill in the coupon at the right.

EVERYDAY MECHANICS PUBLICATIONS, INC.
96-98 Park Place
New York, N. Y.

A Special Offer

and saving are made for readers of this magazine. EVERYDAY MECHANICS will be sent to you for one year at \$1.00; two years at \$1.90; and three years at \$2.70. Remember each issue bought on the newsstand costs fifteen cents the copy.

Mail Coupon Today

EVERYDAY MECHANICS PUBLICATIONS, Inc.
96-98 Park Place, New York, N. Y. RC-7

I wish to take advantage of your special offer. Enclosed find.....for which send me EVERYDAY MECHANICS for.....years. Check one of the following.

1 year for \$1.00 2 years for \$1.90
 3 years for \$2.70

Name

Address

City..... State.....

Chemistry Offers You



A Fortune

If You Want a Job with a Future, Get into Chemistry



T. O'Connor Sloane,
A.B., A.M., Ph.D.,
LL.D.

Chemistry is one of the most ancient and honorable callings known to man. During the Middle Ages its adepts were the advisors of kings. Then it was called a black art and its followers were believed to have supernatural powers.

The chemist of today with his modernized knowledge has secrets a thousandfold more potent at his command. He is the brains behind hundreds of rich industries, which could not exist without his skill. Yet the field of Applied Chemistry has spread so widely that it is difficult to get enough good men to fill the available posts. A chemical expert is always sure of a good income, a respected and confidential position and a guaranteed future. He may also make himself a fortune, as hundreds of chemists have done before him. Did you ever hear of C. M. Hall? He was an American chemist who at the age of twenty-one discovered how to extract aluminum from clay. It was known that this could be done. It remained for someone to experiment and do it. There are innumerable other chemical problems today waiting to be solved. Mr. Hall died a few years ago leaving an estate of many millions of dollars.

WE CAN TEACH YOU AT HOME

In order to become a chemical expert you must have the proper training under experienced teachers. Our faculty knows just how to mold you into a skilful laboratory worker. The head of our staff is Dr. T. O'Connor Sloane, scientist, engineer and author of wide repute. He has had more than fifty years of teaching experience. Our course fits you for an immediate position in a chemical laboratory, and you do not have to give up what you are doing now to learn it. During evenings and week-ends you can work at home on the fascinating experiments and the delightfully simple but comprehensive lessons. A personal tutor is always ready to help you over difficulties and to answer all your questions. Most important of all—the teaching you receive is practical. You can actually use this knowledge to make money, as thousands have done before you.

SPECIAL ADDED EQUIPMENT

At no extra charge every student is given a complete cabinet of chemicals and apparatus for his own use. The illustration gives some idea of what it contains. There are over fifty distinct chemical reagents in the set. But in addition there is something which we have never offered before. The chemical expert needs sharp eyes. For much of his work no human eyes are keen enough. Every modern scientist resorts to the microscope, which is one of the most valuable instruments in home or laboratory.

We Are Now Sending to Each New Student ABSOLUTELY WITHOUT CHARGE THIS VALUABLE MICROSCOPE

It is a beautiful instrument of fine German make and extremely sensitive. Any person not a student of our course may procure one through us at \$25.00, which is somewhat less than the usual price, but to those who enroll the microscope will be given **ABSOLUTELY WITHOUT CHARGE**. With it you will receive a special lesson on its construction and use. The microscope is not loaned to you. It becomes your permanent possession along with all the other equipment and the lessons.

TUITION PRICE REDUCED

No advance in tuition price is occasioned by this newest addition to the apparatus we supply. In fact we have even reduced the fee, so that this splendid course and equipment are within the means of every individual who is interested in following Chemistry, whether as a career or merely as a hobby. Fee can be paid on **EASY MONTHLY TERMS**. The one price covers everything. There are no extras to buy.

MAIL THE COUPON TODAY FOR FREE BOOK

CHEMICAL INSTITUTE OF NEW YORK, INC.

16-18 East 30th Street

New York, N. Y.



We give to every student, without additional charge this chemical equipment, including fifty-two pieces of laboratory apparatus and supplies, and fifty-two different chemicals and reagents. These comprise the apparatus and chemicals used for the experimental work of the course. The fitted heavy wooden box serves not only as a case for the outfit but also as a useful laboratory accessory for performing countless experiments.

Diploma Awarded When You Graduate

Upon graduation every student is awarded our Diploma in Chemistry, certifying that he has successfully completed his studies. Your name on this certificate will be a source of pride to you all your life, as well as an aid in obtaining a position.

CHEMICAL INSTITUTE OF NEW YORK, INC.
Home Extension Division 7
16-18-R, East 30th Street, New York, N. Y.

Please send me at once, without any obligation on my part, your free Book "Opportunities for Chemists," and full particulars about the Experimental Equipment given to every student. Also please tell me about your plan of payment, and the reduction in the tuition price.

NAME

ADDRESS

CITY..... STATE.....

FG-7-30

GREATEST Tube Sale of 1930

Never before has there been such an amazing tube sale as the present one which is being conducted

JUST AS LONG AS THE SUPPLY LASTS

All tubes are warranted to be perfect and all tubes that are returned within five (5) days will be exchanged for new ones free of charge.

This sale has been arranged especially for service men, radiotricians and radio dealers and no further sales will be held once this supply is sold.

These tubes represent over-production by one of the largest Eastern tube manufacturers and are sacrificed for ready cash.

This is a chance that you will never have again.

Order from this page and note particularly the following terms:

NO ORDERS ACCEPTED FOR LESS THAN \$5.00

NO REPLACEMENTS AFTER FIVE (5) DAYS.

IT IS NOT NECESSARY TO SEND THE FULL AMOUNT OF CASH WITH THE ORDER AS LONG AS YOUR ORDER IS ACCOMPANIED BY 20% OF THE VALUE.

SHIPMENT WILL GO FORWARD TO YOU BY EXPRESS OR PARCEL POST C. O. D.

ALL PRICES ARE F. O. B. NEWARK.

IMMEDIATE SHIPMENTS

TYPE	ANY QUANTITY
UX-201A	\$.30
UX-226	.30
UY-227	.30
UX-240	.30
UX-171	.30
UX-171A	.30
UX-120	.30
UX-199	.40
UY-199	.40
UY-199 Standard	.40
UX-210	.40
UX-280	.40
UX-281	.40
UX-112	.40
UX-112A	.40
UX-200A	.40
UY-224	.40
UX-245	.40
UX-250	.40
Special Detector Tube 200A	.60
Special Audio Frequency 201A	.60
Special 171 A.C. 1/2-am. extra coated filament	.60
Special Radio Frequency 201A	.60
T-14 (201A High Mu)	.60
Switch Tube	.75
Adapter Tube 226-227-171A, each	1.00
Quadrode 5-prong 201A	1.00
All bakelite Shield Tube 201A	1.00
UX-222	1.10
Telion	2.85

RECTIFIER AND CHARGER BULBS

125 Mil Tube Rectifying Tube	1.40
2 amp. old and new type (List \$4.00) OUR PRICE	2.00
5 and 6 amp. old type (List \$8.00) OUR PRICE	3.75

DISCOUNTS:

50 tubes and over 10%
500 tubes and over 10% & 10%

ARCO TUBE COMPANY

38-40 PARK PLACE

NEWARK, N. J.

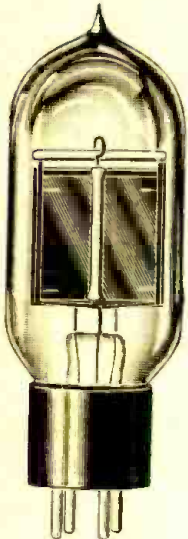

Telion Television Tube



Shielded 201A Tube, entirely covered with Bakelite shield—does away with micro-phonous noises.



High Grade (Hi Mu) 201A Type—better vacuum—works and fits in any set.



All tubes come in this attractive carton.



Switch Tube
Switch is used when one filament burns out, tube therefore has twice normal life. With switch on acts as 171 or 112 Power Tube—with switch off it is 201A Tube.



A.C. Adapter Tubes to convert battery sets into A.C. Electric sets—furnished for 226, 227, 171A.



5-Prong 201A

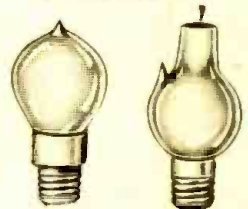

2-Amp. Charger Bulbs.



5 and 6-Amp. Charger Bulbs.

Replacement Parts at a Big Saving

for leading commercial receivers

RCA
VICTOR
EDISON

DEALERS - SERVICEMEN

Numerous radio bargains have often been given to you. But here are the biggest that you have ever read of. All merchandise is of the finest material and manufactured by well-known set manufacturers.

FREED
A. K.
MAJESTIC

R.C.A. Replacement Condenser BLOCK FOR

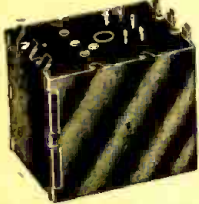

BLOCK FOR



Nos. 17, 18, 33 Sets
Special

PART No. 8333
LIST \$7.40

\$1.50
each

RCA

By-Pass Condenser Part No. 5996



Comprising one 1/2 and three .1 mfd. condensers.

LIST \$3.00
Our Price **35c**



CHOKER COILS



15 HENRYS—35 MILS.
Impregnated in Rosin.
Ideal choke for B Eliminator
and A.C. Sets.
D.C. Resistance 500 OHMS.

Special, **35c**



VICTOR

ABC POWER TRANSFORMERS



Supplies Voltages for
6—226 tubes.
1—227 tube.
1—280 tube.
2—245 tubes.

Can be used in
Loftin-White Circuit.

As used in
Victor sets

Price, **\$2.75**

VICTOR

Audio Transformer



Our Price,
95c

VICTOR

Push Pull Transformers

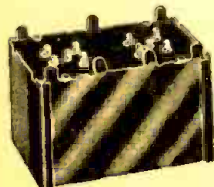

Our Price,
\$2.50
per pair

Grid Suppressors
750 OHM
\$1.00 Per Doz.



RCA Double Filter Chokes

RCA Replacement Part No. 8336 Contains Two 30 Henry 80 Mil Chokes

Special **\$1.70**
each

Each choke insulated for 1,000 volts.

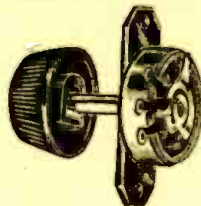

List price \$1.95

YAXLEY 2,000 Ohm Volume Control

RCA Replacement Part No. 5091

For Radiola 17, 18, 32, 42, 44 and practically all sets. Insulating strip (easily removed) for metal panels.

Each **45c**

FROST

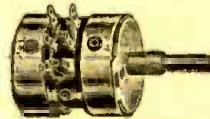

List price \$2.50

Twin Volume Control

3000—3800 Ohms

Will stand up. No more burned out volume controls. Standard for Victor but can be used on all sets.

Our price **55c**
Dozen **\$5.50**

Fixed Pigtail Resistors



OHMS	500	10,000	25,000
2,000	15,000	50,000	
4,700	20,000	250,000	
		500,000	

\$1.00 Per Dozen

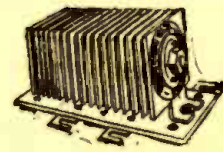

GENUINE NEW TYPE ELKON M-16 RECTIFIER

Officially recognized by Grigsby-Grunow as the proper replacement unit for the Majestic "A" eliminator. May be used on the following "A" eliminators: Majestic, Mayellan, Elkon, Philco, Webster, Knapp, Gen. Inst., Metro, Fada, Bernard, Sentinel, Elkon, and Briggs and Stratton.

FIRST TIME AT THESE PRICES

With Base—**\$3.45**

U-20 Without Base—**\$2.35**

Hart & Hegeman Toggle Switch

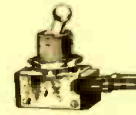

For Battery and Electric Sets Approved by Underwriters

20c each—\$2.15 per doz.
Gen. Elec. Switch 20c.
\$2.15 per dozen

Polymet



BY-PASS TUBULAR CONDENSER
.1 MFD.
200 VOLTS

\$1.00 Per Doz.

Can be used across Choke Terminals in Victor Sets to reduce hum

Polymet



HI-VOLT
1 MFD. FILTER
CONDENSER
300 VOLTS D.C.

35c Each

\$3.65 Per Doz.

BAL-RAD Replacement Blocks

All Brand New and Fully Guaranteed.

Products of an old reliable Manufacturer.

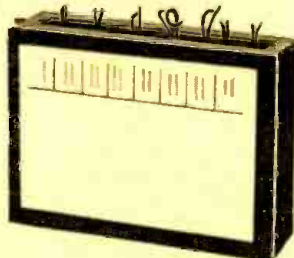

A replacement block for Majestic eliminator—guaranteed for a period of one year. The condensers in this block are all composed of high voltage condensers, and you can be assured that once this block is installed, it will last indefinitely.

\$2.95

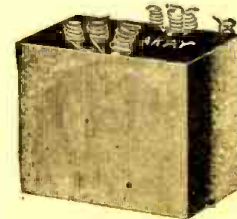

For Atwater Kent Electric Set Model No. 37. This unit contains the proper chokes and high voltages. All flexible wires—colored leads identical to original. Fully guaranteed.

Net

\$4.95

each.

The "BAL-RAD"

Hy-Voltage Uncased Surge-Proof Condensers

For General Repair and Power-Pack Work

1/2 mfd. 300 V 25c. 2 mfd. 600 V 40c.
1 mfd. 600 V 30c. 4 mfd. 600 V 60c.



This "Bal-Rad" Condenser is the result of many suggestions from service men throughout the country. It is small and compact, impregnated in pitch with long flexible leads to facilitate quick connections. Can be placed outside of Pack. We guarantee these Condensers for 100% Free Replacement. Repair men should carry a few dozen in stock.

SEND FOR OUR LATEST BARGAIN CATALOGUE—NO OBLIGATION, OF COURSE

MAIL ORDERS
TO:

BALTIMORE RADIO CO.

47R MURRAY ST., NEW YORK CITY

TERMS:—20% with order, balance C. O. D. 2% discount allowed for full remittance with order only.

BARGAINS *unheard of before!*

DEALERS — RADIO SERVICE MEN: Astounding prices such as presented on this page for merchandise are rarely found anywhere. Advantage of these wonderful buys should be taken NOW. Even stocking them will save you considerable money.

Radiola 44



\$37⁵⁰ with tubes

Regularly listed at \$110.00. This popular model, operated by A.C. lighting circuit, uses three UY-224's, one UX-245, and one UX-280. It is single-dial control and encased in a walnut cabinet. Packed in original factory sealed cartons.

Radiola 33 - - \$32.00 with tubes
Legs for "33" at \$4.50

Peerless Speaker

and Sonora Cabinet

The MELODONIC loud speaker, with a dynamic 10" cone, is enshrined in a beautiful cabinet designed by master craftsmen. Operates from 110 volts, 60 cycles, A.C. current.

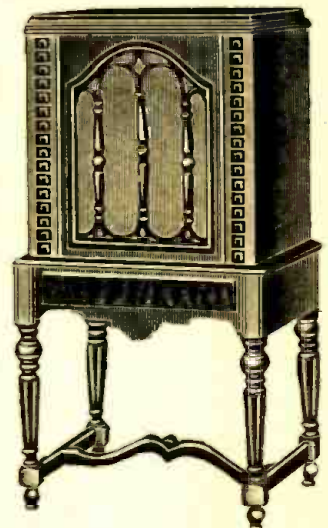

PRICE

\$24⁹⁵

Cabinet only \$13.50

Powertone "B" Eliminator

Operates on 110 volts A.C. 180 volts — "B" Eliminator with 3 taps — variable detector, 45, 90 and 200 volts — with tube

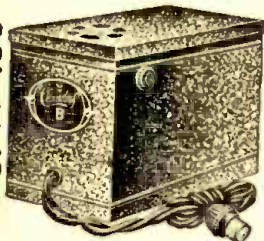

\$10⁹⁵

Readrite No. 245

A handy tester for all circuits, and tubes — for accurate testing. Especially designed for sets using 245 power tube.

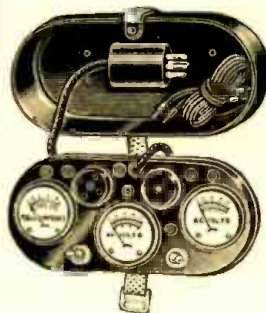

PRICE
\$11⁵⁰

POWERTONE "A" ELIMINATOR

Bone Dry with Tube

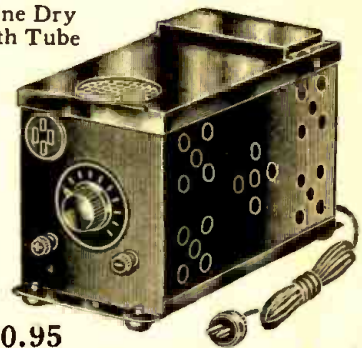

\$10.95

FARRAND

INDUCTOR DYNAMIC CHASSIS

Here is not only true Dynamic operation and performance at a popular price, but opportunity to enjoy Dynamic reception from every type of radio receiver.

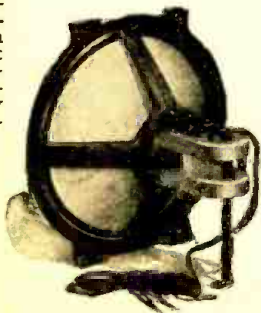

7" Cone
10" Cone
\$8⁴⁹

ALLEN ROTOR

Turn Table for A.C.

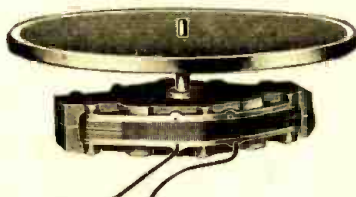

The ROTOR is the one silent electric phonograph motor that is favored by the majority. Motor is 1 1/4" thick—it is a marvel of engineering.

PRICE **\$4⁴⁵**

Pacent Phonovox Pickup

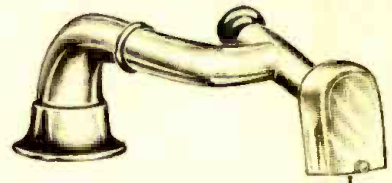

This popular model designed to give only the finer qualities that are to be gotten from your receiver. Unusually clear reception.

PRICE **\$3⁷⁵**

All merchandise purchased must be accompanied by a remittance of 20%. Balance C.O.D. with order. F.O.B. New York City. 2% discount for full remittance with order.

Radio Surplus Corp.

56R VESEY ST. - - NEW YORK, N. Y.

Dealers are requested to send for our latest bulletin showing real bargains in excellent radio merchandise.

NEW SCREEN GRID *Bargains* GRID

That cannot be Duplicated!



\$55⁰⁰

*Complete with
Champion Tubes*

Specially selected walnut veneers; gorgeous burl panels and overlay. Highest quality lacquer finish. Harmonizes with any surroundings. 40 in. high, 25 in. wide, 14 in. deep. Former list price, \$160.00.

Mr. Service Man, here is your opportunity—CASH IN ON IT!

An unusual combination of circumstances makes it possible for us to offer you the most astounding bargain in the history of radio. We are distributing a limited number of the most thoroughly modern and efficient radios ever developed at a fraction of their value. Not trade-ins or demonstrators but brand new, **GUARANTEED PERFECT** receivers incorporating every feature and refinement to be found in the latest 1931 jobs. They have Screen-Grid R.F. tubes; 245 push-pull audio amplification; full shielded rust-proof chassis and appearance that will sell them on sight.

Your customers will be immediately fascinated by their tremendous power and quiet, humless performance. They will reach out and bring in "DX" that you will be proud to demonstrate and at the attractive price you can place on them they will positively sell themselves.

Two console models are available, both of which are a gem of the cabinet maker's art. All are supplied with quality dynamic speaker and a complete set of First Quality Champion tubes. **NOTHING ELSE TO BUY!**

In view of the limited supply to meet the demand that this amazing bargain will undoubtedly create; the foresight of your prompt action is evident.

Hi-Boy

Rare and carefully chosen veneers are combined in this console to make a piece of furniture of unusual charm. A fine radio that anyone will be proud to own. Former list price, \$192.00.

Low-Boy

One of the smartest models ever designed.



\$69⁰⁰

*Complete with
Champion Tubes*

CHASSIS

\$29⁰⁰

SPEAKER

\$9⁰⁰

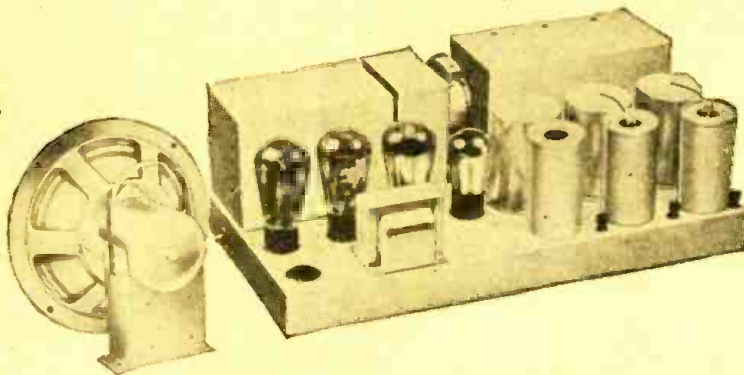

**AMAZING VALUES IN
CHASSIS AND SPEAKERS**

Replace obsolete chassis with this modern screen-grid job. Easily installed in any standard console. Size: 20 in. long, 11 in. deep, 7½ in. high. Tubes used: two '24s, two '27s, two '45s and one '80.

MODEL 30 SG CHASSIS, now net to you, without tubes\$29.00

HIGH QUALITY DYNAMIC SPEAKER for use with this chassis, only 9.00

HOW TO ORDER: You may place your order with us by simply writing us a letter, or if you prefer tear out this page and, indicating your selections, enclose it with your remittance. Shipments are made promptly upon receipt of your order.

Pioneer Motorradio Co.

563-571 W. RANDOLPH ST.

CHICAGO, ILL.

WHAT EVERY ELECTRICIAN WANTS TO KNOW!

JUST OUT!—Latest Exact Information from A to Z!

We take pleasure in announcing: "AUDELS NEW ELECTRIC LIBRARY"

New and More Uses for Electricity offer great opportunities to men who can handle this power correctly. Modern electrification of industry calls for trained men who know how to handle electricity accurately.

Simple as A. B. C.—"Audels New Electric Library" gives latest, exact information from foundations of electrical practice to latest modern applications. This is a NEW practical and theoretical course in electricity for home study and ready reference.

Here are the answers to your questions, giving you the real dope that every electrician must know. They chart your knowledge, taking away the uncertainty of guess work.

NEW!

As Easy As ABC



Latest information, fully illustrated, covering:—

Fundamental Principles and Rules of Electricity, Magnetism, Armature Winding, Repairs, Dynamos, D.C. Motors, Construction, Installation, Maintenance and Trouble Shooting, Tests and Testing Instruments, Storage Battery, Construction and Repairs, Alternating Current Principles and Diagrams, Power Factor, Alternators, Transformers, A.C. Motors, Windings, Reconnecting, Converters, Switches & Fuses, Circuit Breakers, Relays, Condensers, Regulators, Rectifiers, Meters, Switchboards, Power Station Practice, House Light & Power Wiring, Circuits, High Tension, Transmission, Plans, Calculations, Code, Electric Railways, Signals, Elevators, Hoists & Cranes, Gas Engines, Auto & Aero Ignition, Starters, Radio, Telephone, Telegraph, Bells & Signals, Motion Pictures, Talkies, Lighting, Illumination, Electric Refrigeration, Heating, X-Ray, Plating, Welding, Pumps, Compressors, Domestic & Farm Appliances, An Electric Calculator for Engineers and Mechanics, Practical Mathematics for Ready Reference, A New Electric Dictionary & Encyclopedia of Words.

7 Books Now on Sale
5 in Preparation

The Library contains 12 books—the first 7 books containing 3600 pages with thousands of diagrams and illustrations are now ready; the remaining 5 books are in preparation. A pocket-size, flexibly bound series that is valuable wherever electricity is used.

Beautiful, timely books for service—pocket size; completely illustrated with diagrams and charts; simplified, easy to read and understand. No electrical man can afford to pass up this opportunity. Extremely low price; buy on your own terms.

BUY ON YOUR OWN TERMS

- PLAN 1—ONE BOOK A MONTH**
Please enter my subscription to "Audels New Electric Library" to consist of twelve volumes, price \$1.50 a volume (\$10.50 for the seven volumes now ready). Mail one volume each month and as they are received, I will mail you \$1.50 promptly.
- PLAN 2—PAY 50c OR MORE A WEEK**
Please ship me for one week's free trial the first seven volumes of "Audels New Electric Library," \$1.50 each (\$10.50 for the seven volumes now ready). The remaining five volumes to be mailed as issued at \$1.50 a volume. If satisfied, I will mail you 50c or more each week as payment for the first seven books and I will pay for the last five numbers as I receive them at \$1.50 each.
- PLAN 3—CASH PRICE \$9.95**
Please ship me postpaid "Audels New Electric Library" for which I enclose remittance \$9.95 in full payment for the seven volumes now ready. You are to ship me on one week's trial the remaining five volumes as they are issued for which I will either pay \$1.50 each as received or return to you. This price is based on 5% cash discount.

THEO. AUDEL & CO.,
65 West 23rd St., New York, N. Y.

Please ship me the NEW "Audels Electric Library" on the plan marked (X).

NAME

ADDRESS

OCCUPATION

EMPLOYED BY

Beautiful, Timely Books

POCKET SIZE

Read for Profit

QUESTIONS AND ANSWERS
AUDELS NEW ELECTRIC LIBRARY ILLUSTRATED

NEW!

SATISFACTION GUARANTEED!
"Audels New Electric Library" is backed by our 50-year record as helping hand publishers. Satisfaction always guaranteed.



Again at the RMA Show!

the spotlight plays on the

SUPREME DIAGNOMETER Model 400B

conceivable

Makes every Test on any Radio Set—

UNIVERSALLY recognized as the undisputed leader of radio testing equipment, the SUPREME DIAGNOMETER enters a new season of unusual service to RADIO DEALERS, TECHNICIANS, MANUFACTURERS AND SERVICE MEN—

Dealers' Net Price, f.o.b., Greenwood, Miss. Size 7½x12x16½..... **\$139.50**

Also available in a smaller case for radio-man who does not care to carry spare parts, tubes, etc., in same unit.

Supreme Features

The SUPREME oscillation test gives the only, easily made, dependable test on tubes; tubes tested under radio frequency dynamic operating conditions.

Tests all types of tubes, including screen-grid and overhead heater types.

Affords a mutual conductance test of tubes.

Tests both plates of '80 type full-wave rectifier tubes.

All tubes tested independent of radio.

Locates unbalanced transformer secondaries.

Reads either positive or negative cathode bias.

Furnishes modulated signal for testing, synchronizing, neutralizing, etc.

Provides means for aligning of condensers by Thermo-couple meter or A-C meter.

Neutralizing with tubes used in the set; only accurate method.

Tests gain of audio amplifiers.

Provides D-C continuity tests without batteries.

Indicates resistances, without the use of batteries, in four ranges. .1 to 25 ohms, 10 to 200 ohms, 150 to 30,000 ohms (calibration curve furnished), 5000 ohms to 5 megohms.

High resistance continuity for checking voltage dividers, insulation leakages, by-pass and filter condenser leakages, bias resistors, grid leaks, etc.

Low resistance continuity for checking rosin joints, shorted variable condensers (without disconnecting R-F Coil), center tapped filament resistors, etc.

Three precision meters: one four-scale D-C voltmeter, 0/750/250/100/10 volts, resistance 1000 ohms per volt. One four-scale A-C voltmeter 0/750/150/16¼ volts. One three-scale mil-ammeter 0/125/25 mils. 0/2-½ amps.

External connections to all apparatus.

Universal analyzer plug.

Screen-grid socket analysis.

Makes all analysis readings. Provides simultaneous plate current and plate voltage readings and the customary readings of A-C and D-C filament voltage, grid voltage, cathode bias, screen-grid voltage, line voltage, etc.

Measures capacity of condensers from .1 mfd. to 9. mfd.

Tests trickle charger by meter.

Bridges open stages of audio for testing.

Contains 500,000-ohm variable resistor, 30-ohm rheostat and .001 mfd., .002 mfd. and 1 mfd. condensers for testing.

The laboratory test panel is equipped with a variable condenser for controlling the frequency of the oscillator.

Pentode Testing and Analysis.

Servicing Auto Receivers.

Provides many other tests, readings and functions.

SUPREME

Testing Instruments

"SUPREME BY COMPARISON"

include Tube Testers, Tube Checkers, Ohmmeters, Megohmmeters

Unapproached! Unchallenged!
Unchanged—except for the addition of Pentode testing to its almost limitless servicing functions!

Supreme Diagnometer Will Continue to Occupy Its Present Envious Position Because,

It is designed and manufactured on a Quality basis for permanency. New sets and circuits mean only added sources of revenue.

It gives the service man MORE for his investment, providing endless testing and servicing combinations and

It enables him to handle a GREATER amount of servicing in LESS time . . . at a greater PROFIT—

It creates SATISFIED CUSTOMERS and thus establishes PRESTIGE—

It offers an equal facility for EITHER PORTABLE OR LABORATORY WORK—

It will admirably handle servicing of AUTO RECEIVERS, and is designed for PENTODE testing and analysis.

It pays to insist on the BEST . . . especially in purchasing radio testing equipment. INVEST WISELY in a SUPREME DIAGNOMETER and clip the coupons of regular dependable PROFITS FROM YOUR RADIO SERVICING!

Most good distributors carry the SUPREME DIAGNOMETER in stock. If yours cannot supply you, send order direct on accompanying form.

SUPREME INSTRUMENTS CORPORATION
GREENWOOD, MISS.

Distributors in all principal cities

Service Depots in
New York, Pittsburgh,
Chicago, Kansas City
Seattle, San Francisco
Toronto

Supreme Instruments Corp.
366 Supreme Bldg.
Greenwood, Miss.

Please ship SUPREME DIAGNOMETER Model 400-B on basis checked below.

Net cash \$139.50.

Time payment plan—\$33.50 cash and 8 monthly payments of \$15.00 each.

All prices are F. O. B. Greenwood, Miss. No dealer's discount.

Date shipment desired.....

Signed.....

Firm Name.....

Street Address.....

City.....

State.....

Please give three or more bank or trade references and names of distributors from whom most purchases are made.